

Demonstration of minute continuous-wave triggered supercontinuum generation at 1 μm for high-speed bio-photonic applications

Yi Qiu, Chi Zhang, Kenneth K. Y. Wong, and Kevin K. Tsia*,
Department of Electrical and Electronic Engineering, The University of Hong Kong,
Pokfulam Road, Hong Kong;

ABSTRACT

Ultra-broadband supercontinuum (SC) at 1- μm wavelength is regarded as diagnostics window in bio-photonics due to its large penetration depth in tissues and less Rayleigh scattering. Dispersive Fourier transform (DFT) is an important technique to realize the high-speed, ultra-fast and high-throughput spectroscopy. Thus, a stable light source with good temporal stability plays an important role in the bio-imaging and spectroscopy applications. We here demonstrate stabilized and enhanced SC generation at 1 μm by a minute continuous-wave (CW) triggering scheme. By introducing a weak CW ($\sim 200,000$ times weaker than the pump), a significant broadening in the SC bandwidth and an improvement in the temporal stability can be obtained. Over 8 dB gain is achieved in both blue and red edges and the SC spectrum can span from 900 nm to over 1300 nm with the CW trigger. We present the CW-triggered SC capability of enabling high-speed spectroscopy based on DFT at 1 μm . In regards to the performance of DFT, the wavelength-time mapping fluctuation reduced by 50% which is an indication of the improvement of the temporal stability. This triggering scheme allows, for the first time, 1- μm DFT at a spectral acquisition rate of 20 MHz with good temporal stability – paving the way toward realizing practical real-time, ultrafast biomedical spectroscopy and imaging.

Keywords: continuous-wave triggered supercontinuum, ultra-fast imaging, spectroscopy, dispersive Fourier transform, temporal stability, real-time bio-imaging

1. INTRODUCTION

Due to its large penetration depth in tissues and less Rayleigh scattering, ultra-broadband supercontinuum(SC) at the 1- μm wavelength range, which is regarded as a diagnostic window in bio-photonics, represents a versatile light source for a wide range of bio-imaging and spectroscopy applications. In particular, applications which require high-speed and high-throughput operations, such as real-time high speed spectroscopy based on dispersive Fourier transform (DFT) and serial time-encoded amplified microscopy (STEAM), demand for the robust SC source with not only a broadband spectrum but also a good shot-to-shot temporal amplitude stability. It is because that the broadband spectrum and the stable temporal amplitude provide a prerequisite of ultra-fast bio-imaging and stability in the frame-to-frame image quality respectively. Although SC pulses offer ultra-wideband spectrum which spans more than one octave and being considered as a preferable light source for a wide range of applications, the performance of ultra-fast data acquisition using SC can be limited by its temporal instability especially for the long pulse SC (e.g. picosecond or nanosecond) which has been widely used in the bio-photonics applications. In the anomalous group-velocity dispersion (GVD) regime, the spectrum broadening mostly is contributed by soliton fission, which is initiated by modulation-instability (MI) [1]. However, the SC generated by MI is incoherent and temporally unstable because MI grows from noise; as a result, the soliton fission is triggered in a random fashion [2]. This instability of SC does not meet the requirements to perform good bio-imaging and spectroscopy applications [3, 4]. In this paper, we demonstrate a simple triggering scheme based on an extremely weak continuous-wave (CW) to enhance the SC generation and promote the SC temporal stability. The advantage of our proposed scheme lies in that it does not require the complex techniques such as precise time delay tuning [5] or dedicated feedback control [6]. In this work, a wideband SC from 900nm to $> 1200\text{nm}$ is achieved and in the DFT process, a stable sing-shot spectral acquisition at a speed of 20MHz is achieved. The shot-to-shot fluctuation can be greatly reduced by introducing a weak CW and thus improve the spectral quality efficiently. [7 - 8]

2. EXPERIMENTAL SETUP

The SC in this experiment is generated by an intense pump pulse from a picosecond mode-locked fiber laser (FMHM ~ 7 ps, center wavelength 1064 nm) with a repetition rate of 20 MHz, and a peak power of ~ 3500 W, which passes through a 20-meter-long highly-nonlinear photonic crystal fiber (PCF) with a zero-dispersion wavelength of ~ 1060 nm. Thus, the PCF is pumped at the anomalous dispersion regime. A wavelength tunable CW laser diode is coupled with the pump by a beam splitter (BS) with the splitting ratio of 98:2. After two beams are combined, the light is coupled into the PCF by the objective lens (OBJ). Then the generated SC is then coupled into a beam collimator (BC) and connected to the optical spectrum analyzer (OSA) with a 1-meter long 1- μm single-mode fiber (SMF) to analyze the spectrum (path 1). To analyze the temporal stability of the different wavelength region, different long-pass filters (LP) are used to filter out certain region of wavelength and then connected to the oscilloscope with an electrical bandwidth of 4 GHz and sampling rate of 20 GSa/s (path 2). The part in the dotted box shows the DFT part, a 5km-long 1060XP is used as the dispersive element, which is an SMF at 1 μm with a total dispersion of -150 ps/nm.

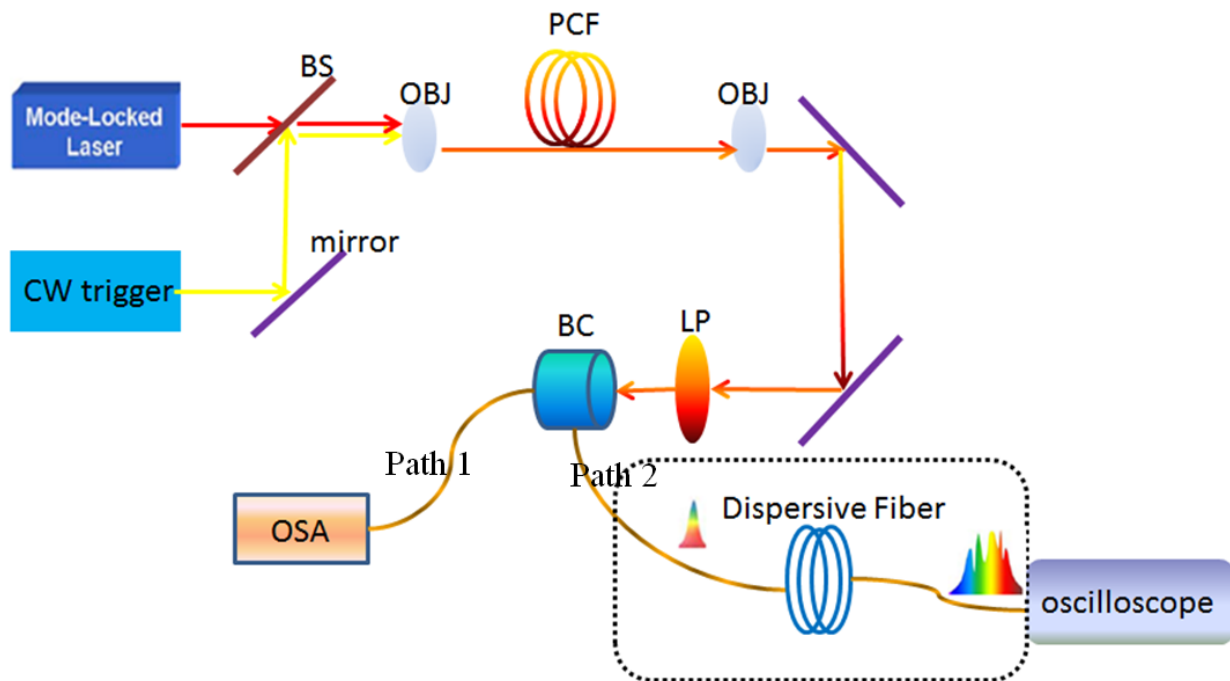

Figure1. Schematic design of CW-triggered mechanism for manipulating SC generation.

3. RESULTS AND DISCUSSION

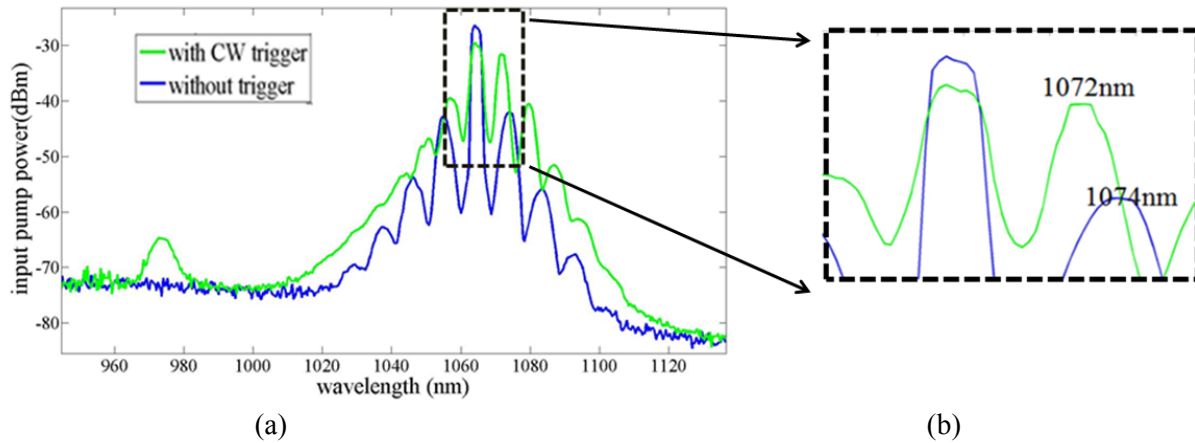
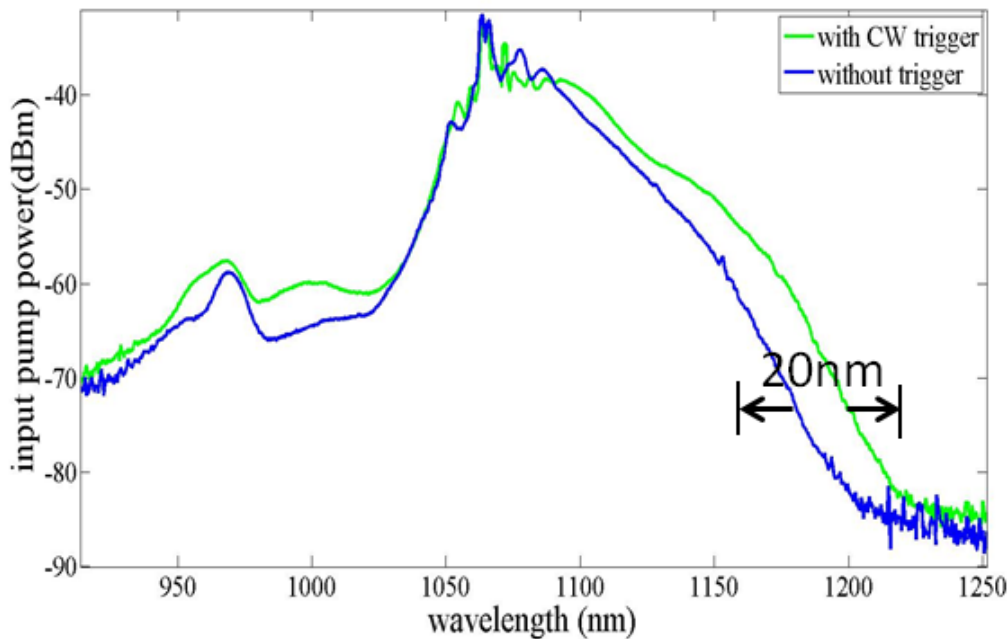
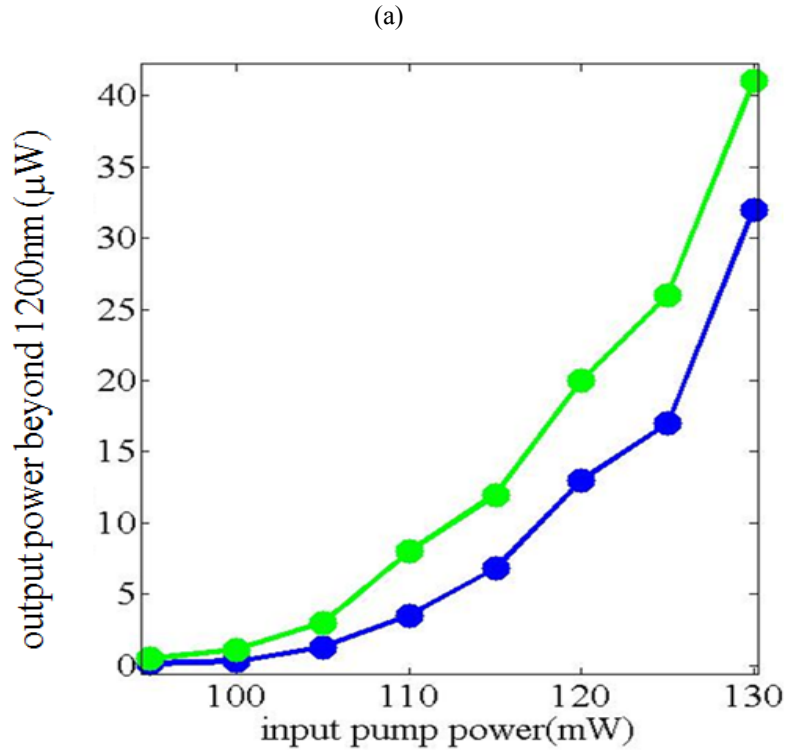

Figure 2. The SC spectrum of comparison between the CW triggered case and the one without CW triggered.

The SC is generated by a pulsed pump with average power of 50mW and a CW trigger input power of 3 mW at the wavelength of 1072nm. The spectrum in Fig. 2(a) shows the comparison between the SC with CW trigger (green) and without CW trigger (blue). More than 8 dB gain is observed for both red-shift and blue-shift side. The Fig. 2(b) shows that the MI peak is shifted from 1074 nm to 1072 nm with the CW trigger. It indicates that with CW triggering, the initial condition of the SC generation has been modified, and the SC broadening which initiated by MI in this case is controlled by the CW at wavelength of 1072 nm instead of the random noise. It can be understood by that the higher-order coherent FWM components generated by the CW-trigger can create a more deterministic beating effect on the pump pulse. This is in a good agreement with our recent numerical study on CW-trigger SC generation [9].





(b)
 Figure 3. (a) The triggered SC spectrum is 20 nm wider than the SC without trigger; (b) The power for the long-passed triggered SC (>1200 nm) as a function of input pump power.

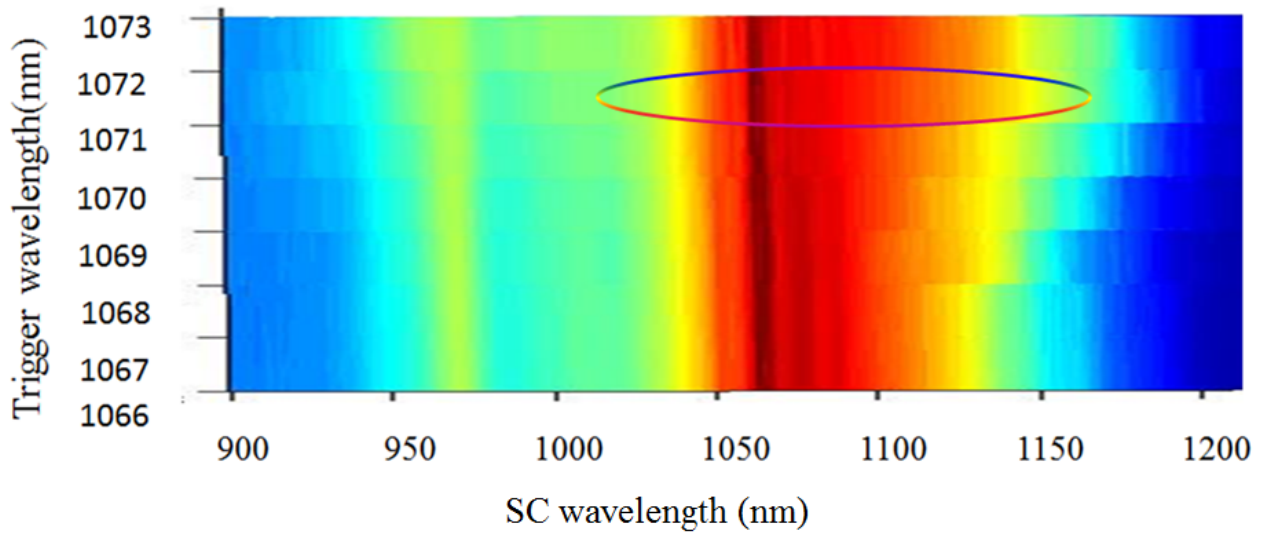

Figure 4. 3D top view plot of SC spectrum with CW triggering from 1066 nm to 1073 nm.

Fig. 3(a) shows the SC spectrum at input pump power of 60 mW. At this power level, the generated SC is at the threshold where the SC is transformed from the MI process to the soliton fission, which subsequently leads to the rogue soliton. The triggered SC spectrum spans from 900 nm to almost 1250 nm, and the spectrum is more than 20 nm wider than the SC without trigger. A long-pass filter is used to select the wavelength beyond 1200 nm, where this red-edge of the SC spectrum is mostly contributed by the Raman soliton, which is the rogue soliton. As the input pump power is

increased, it is observed that in Fig. 3 (b) that the power of SC after 1200 nm with CW trigger increases more rapidly compared with the one without trigger; especially after the input pump power exceed 100 mW. This indicates that the weak CW trigger can enhance the SC power especially in the rogue soliton region.

Figure 4 shows a top view of a 3-dimension SC spectrum triggered by different CW wavelengths from 1066 nm to 1073 nm. It is observed that as the CW wavelength approaching the MI peak (around 1072 nm for this power level), the enhancement is the most significant (see the highlighted part), and it decreases as the CW-trigger wavelength tuning away from the MI peak.

We also observe that the CW trigger greatly enhances the SC power stability. A real-time wavelength-time mapping technique is employed by a real-time oscilloscope to study the SC stability. From Fig. 5, the temporal stability of different wavelength region from 1100 nm to 1200 nm is studied. Each SC power histogram is plotted with 400 pulses captured in a single shot. For the SC wavelengths beyond 1100 nm (1st row) we can observe that the standard deviation of the Gaussian-like histogram decreases as the CW-trigger wavelength approaches the MI peak wavelength (i.e. at 1072 nm). At the CW-trigger wavelength of 1072 nm, the standard deviation of the SC power histogram is decreased by 83.3%. For the SC wavelengths > 1150 nm and 1200 nm, (2nd and 3rd rows), the histogram without CW trigger shows a clear long tail distribution which is a signature of extreme-value statistics and also the key feature of the optical rogue wave [2]. In contrast, the SC power histograms with CW triggering resemble Gaussian distribution with the mean values greatly larger than the untriggered case especially in the 3rd row, which is the wavelength close to rogue soliton. This indicates that temporal stability is greatly improved by the weak CW triggering, and the improvement is particularly prominent when the CW wavelength is at the MI peak. It is because the CW-trigger experiences the largest MI gain which greatly facilitates the establishment of a more well-defined Akhmediev Breather (AB) condition in the presence of noise – a precursor of the soliton fission and other high-order effects which results in the onset of SC. Thus, when the CW is sitting at the MI peak wavelength, the initial condition is thus greatly modified, and the SC generation is initiated by the controllable CW at this particularly wavelength (having the largest gain) instead of noise. It is also observed that the SC close to 1100 nm has the best temporal stability compared with other wavelength region. This wavelength range shows a good potential for real-time and high-speed spectral measurements due to the good temporal stability. We note that the rogue soliton region (1200 nm) also shows a great improvement in the SC stability.

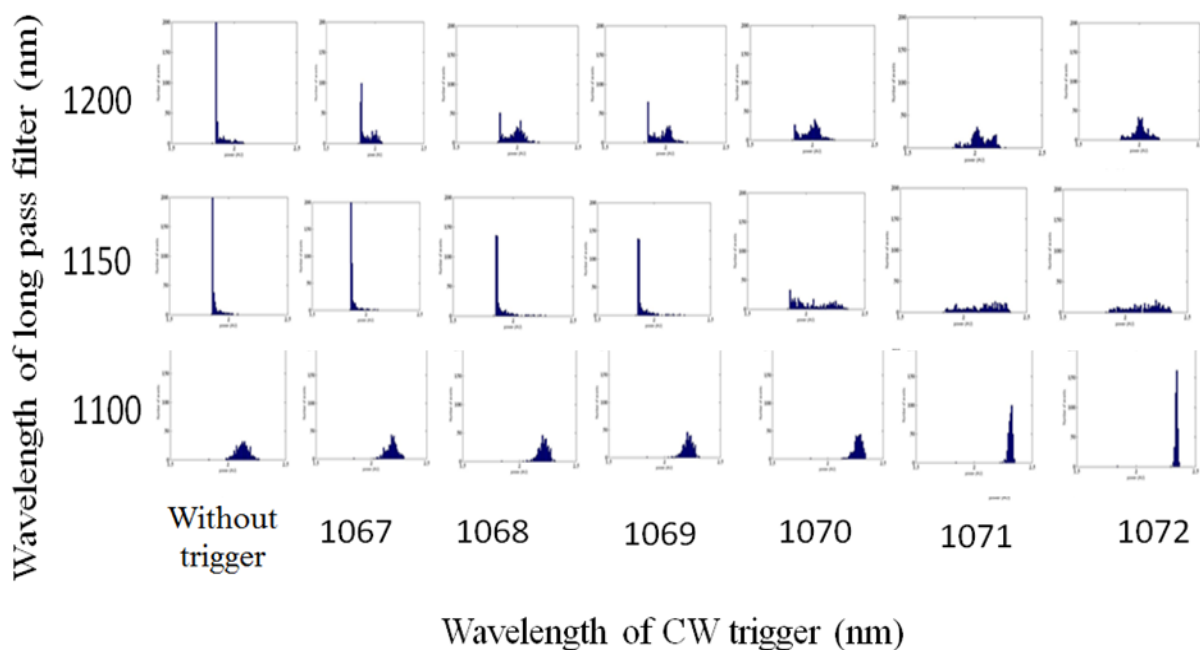

Figure 5. Temporal power histograms of the SC at difference SC wavelength regions. The x-axis and y-axis for each small figure are the SC power (0.5/div a.u.) and number of events (50/div) respectively. The MI peak wavelength is 1072nm

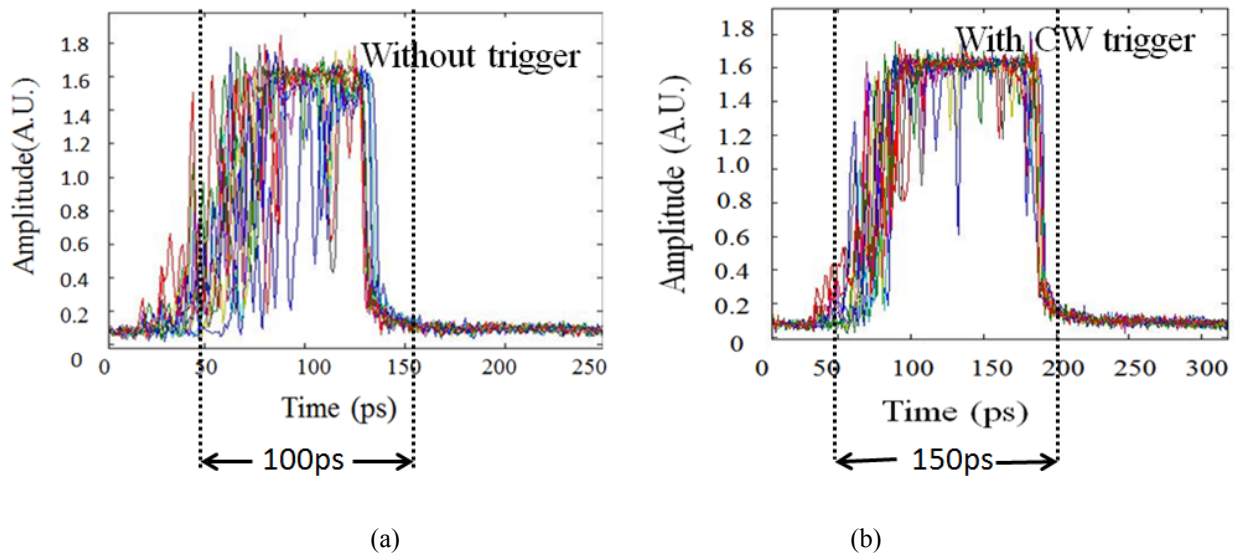

Figure 6. Wavelength-time mapped image for (a) SC spectrum without CW trigger and (b) with CW trigger. The signal of the SC with CW trigger is 50ps wider than the one without trigger.

One of the applications for the SC power stabilization is DFT, which is the key technique of real-time and ultra-fast spectroscopy [10]. In a DFT process, the spectral information is mapped into the time domain using group dispersion velocity (GVD). Dispersive fiber and a single photodetector is used in the DFT system instead of spatial disperser (i.e. diffraction grating) and detector array (e.g. CCD) which greatly simplified the system and realize ultra-fast and real-time spectroscopic measurement by allowing the optical spectrum to be mapped in time domain directly. Since the loss always comes together with dispersion, there is a tradeoff between large loss and high dispersion. However, this tradeoff can be compromised by simultaneously amplify the signal in the optical domain which is known as ADFT. Figure 6(a) and (b) show the overlapped filtered SC spectra mapped into the time domain in a single shot without the CW-trigger and with the CW-trigger, respectively. A 150-nm wide SC spectrum (from 1070 nm to 1120 nm) passes through a 5-km long dispersive fiber with dispersion of -150 ps/nm, and is mapped into time domain with the acquisition rate of 20 MHz. This wavelength region near 1 μm is regarded as a common bio-photonics application window due to the compromise of water absorption and Rayleigh scattering. This is, to the best of our knowledge, the first demonstration of DFT process at the 1 μm regime. In addition, as has been illustrated in the Fig .5, the shot-to-shot temporal power stability around 1 μm is very stable. From the temporal data in the time domain, it can be observed that the signal with CW trigger expands by 50 ps wider than the one without trigger, which indicates that the CW trigger enhances the SC spectral broadening according to the wavelength-time mapping. In both cases, 10 pulses from the one single shot pulse train are overlapped together. The overlapped spectra show large fluctuation especially for the longer wavelength region around 1120 nm for the SC without trigger. On the contrary, when the SC is triggered by the weak CW, the overlapped spectra become more discernible, and the power fluctuation reduces by over 50%, which indicates that the power stability is greatly improved by the CW trigger and also indicates better spectral data quality. We note that cleaner mapping can be achieved by performing spectral averaging at the expense of the acquisition rate. Nevertheless, reasonable averaging (i.e. ~ 10) can maintain the operation order-of-magnitude faster than the conventional spectrometer, simply because of the ultrafast spectral acquisition rate ($>10\text{MHz}$) offered by the DFT technique. This DFT technique can be combined with the Raman amplification or parametric amplification to perform amplified dispersive Fourier transform (ADFT) which allows the spectral information of real-time being mapped into the time domain and enhances the detection speed and sensitivity.

4. CONCLUSION

In the context of the DFT-based techniques, we have proposed and demonstrated, for the first time, the 1- μm DFT, which is enabled by the SC generation based on a minute continuous-wave triggering mechanism. By introducing an extremely weak CW ($\sim 200,000$ times weaker than the pump peak power), we observe that the standard deviation of the SC shot-to-shot amplitude variation is reduced by 83.3% in the 1100 nm wavelength region. It is also observed that, as the CW wavelength get closer to the MI wavelength; the temporal stability keeps on improving. Furthermore, wide SC spectral range which spans from 900 nm to 1200 nm and more than 8 dB power enhancement on both red-shifted and blue-shifted regions are achieved with the CW triggering. Also, we found that the weak CW helps to improve the stability on the rogue soliton region of the SC. This 1- μm CW triggered SC helps expanding the operation regime of prior works on DFT to the 1- μm window – a well-recognized biophotonics window. We demonstrate that the wavelength-time mapping quality in 1- μm shows reasonably good improvement in the presence of the CW-trigger. The CW-triggered SC at 1- μm enables robust DFT operation – making it possible to realize real-time, ultrafast, and single-shot spectroscopy.

5. ACKNOWLEDGEMENT

This work is partially supported by grants from the Research Grants Council of the Hong Kong Special Administrative Region, China (project nos. HKU 7179/08E, HKU 7183/09E, and HKU 717510E).

6. REFERENCES

- [1] J. M. Dudley, G. Genty and S. Coen, "Supercontinuum generation in photonic crystal fiber," *Rev. Mod. Phys.*, **78**, 1135 (2006).
- [2] D. R. Solli, C. Ropers, P. Koonath and B. Jalali, "Optical rogue waves," *Nature (London)*, **450**, 1054 (2007).
- [3] K. Goda, K. K. Tsia and B. Jalali, "Serial time-encoded amplified imaging for real-time observation of fast dynamic phenomena," *Nature*. **458**, 1145 (2009).
- [4] D. L. Marks, A. L. Oldenburg, J. J. Reylonds, "Study of an ultrahigh-numerical-aperture fiber continuum generation source for optical coherence tomography," *Opt. Lett.*, **27**, 2010 (2002).
- [5] D. R. Solli, C. Ropers, P. Koonath and B. Jalali, "Active Control Rogue Waves for Stimulated Supercontinuum Generation," *Phys. Rev. Lett.*, **101**, 233902 (2008).
- [6] J. N. Kutz, C. Lyngå, and B. J. Eggleton, "Enhanced Supercontinuum Generation through Dispersion-Management," *Opt. Exp.*, **13**, 3989 (2005).
- [7] Chi Zhang, Yi Qiu, Rui Zhu, Kenneth K. Y. Wong, and Kevin K. Tsia, "Serial time-encoded amplified microscopy (STEAM) based on a stabilized picosecond supercontinuum source," *Opt. Express* **19**, 15810-15816 (2011)
- [8] Kim K. Y. Cheung, Chi Zhang, Yue Zhou, Kenneth K. Y. Wong, and K. K. Tsia, "Manipulating supercontinuum generation by minute continuous wave," *Opt. Lett.* **36**, 160-162 (2011)
- [9] Qian Li, Feng Li, Kenneth K. Y. Wong, Alan Pak Tao Lau, Kevin K. Tsia, and P. K. A. Wai, "Investigating the influence of a weak continuous-wave-trigger on picosecond supercontinuum generation," *Opt. Express* **19**, 13757-13769 (2011)
- [10] Goda, K , Solli,DR , Tsia, KK , Jalali, B "Theory of amplified dispersive Fourier transformation" *Physical Review A - Atomic, Molecular, and Optical Physics* (2009)

*Email: tsia@hku.hk