

A Neo-Reflective Wrist Pulse Oximeter

GRANTHAM PANG, (Senior Member, IEEE), and CHAO MA

Department of Electrical and Electronic Engineering, the University of Hong Kong, Hong Kong

Corresponding author: G. Pang (gpang@eee.hku.hk)

This work was supported by the CRGC through The University of Hong Kong, Hong Kong, under Grant 104002477.

ABSTRACT This paper relates to a genuine wrist pulse oximeter, which is a noninvasive medical device that can measure the pulse rate and oxygen saturation level in a person's blood. The device is novel due to its innovative design. It is a new type of reflective oximeter, which has a concave structure for housing the optical source and sensor. The neo-reflective sensor module of the device is designed to send the sensor data to a nearby intelligent mobile phone using wireless data transmission. The pulse oximeter has been developed and calibrated, and the calibration curve was analyzed. The innovative design of this pulse oximeter would enable the user to wear the low-cost device on one wrist continuously throughout the day, without the inconvenience of a conventional finger pulse oximeter.

INDEX TERMS Biomedical sensor, pulse oximetry, blood oxygen saturation, wrist oximeter, reflective oximetry.

I. INTRODUCTION

A pulse oximeter is a non-invasive medical device that can measure the pulse rate and oxygen saturation level in a person's blood. People with cardiac or pulmonary disease may check on their blood oxygenation continuously, especially while jogging or exercising. Pilots use them to determine if they need supplemental oxygen, especially when they fly a non-pressurized airplane. When climbing on high altitudes, alpinists may use pulse oximeters as well.

In the blood vessels, the hemoglobin with oxygen are called oxygenated hemoglobin (oxy Hb), whereas the hemoglobin without oxygen are called deoxygenated hemoglobin (deoxy Hb). The basic principle of operation of a pulse oximeter depends on the use of LED light, which is used to determine the oxygen saturation. In particular, red LED light of around 630nm wavelength and infrared LED light of around 880nm wavelength are utilized. (Some pulse oximeters use LEDs of around 660nm and 940 nm wavelengths.) It must be noted that oxy Hb absorbs red and infrared light differently. One fundamental property is that oxy Hb absorbs more infrared light than red light, whereas deoxy Hb absorbs more red light than infrared light. A pulse oximeter calculates the oxygen saturation by comparing how much red light and infrared light are absorbed by the blood.

Currently, there are many different models of pulse oximeters in the market. They differ in size, quality and cost. The complex ones used in hospitals are typically large and not portable. However, there are many hand held pulse oximeters for home use which are very compact and easy to use.

The most common model is the finger model, which displays the blood oxygenation level (SpO₂) and pulse rate.

A wrist-finger model is very common in the market [1]. The device is actually a finger model as the sensor is placed on a finger which is then connected to a wrist display. Yet, the pulse oximeter on the finger is quite noticeable and the finger may not be too comfortable for long period and continuous monitoring. Early work on reflectance type of pulse oximeter have been carried out by Mendelson et al. [2], [3]. Design to lower the power consumption has also been studied in [4] and [5].

The development of a small-sized reflectance pulse oximeter was investigated by Santha et al. [6]. The distance between the light sources and the detector was examined, as well as the pressure of the reflective pulse oximeter sensor head onto the skin. In [7], a reflectance pulse oximeter with circuitry and method for obtaining the percentage of oxygen saturation is given. A microcomputer is used for the signal processing, as well as the calculation of the oxygen saturation based on the input light intensity signals.

A wrist-worn pulse oximeter is described in [8] which has illustrated the feasibility of reflectance oximetry based on a sensor mounted onto a wrist band. The motivation is that the typical finger-tip model is a transmittance pulse oximeter, and is practical only when the patient is hospitalized or lying steadily. Usually, the sensor would press on a finger or the ear lobe which would sometimes cause discomfort or pain as the sensor would block the blood flow. In their prototype model, the reflectance sensor and LED light source are mounted onto

a wrist band of width 30mm. The wristband sensor design is novel and a wireless data transmission module would further enable the data to be sent to a remote receiver for processing and display. Yet, the calibration of the oximeter and further details on the implementation are not shown.

In [9], a ring-shaped photodiode designed for use in a reflectance pulse oximetry sensor is shown. Li and Warren [10] have also developed a small and low-cost wireless reflectance oximeter suitable for wearable and surface-based applications including at the wrist location. High quality photoplethysmographic (PPG) data can be collected. Further signal processing is needed to obtain the actual value of oxygen saturation. In [11], another reflectance type PPG device is developed for the continuous monitoring of arterial oxygen saturation. The result obtained was in good agreement with the finger PPG.

II. THE INNOVATIVE FEATURES OF A NEO-REFLECTIVE WRIST PULSE OXIMETER

In this paper, we present another novel reflective wrist pulse oximeter that has been developed in our laboratory. As mentioned in the previous section, recent mature technology and products of oximeter are mostly based on the principle of transmittance of light through a finger. However, oximetry based on the principle of light reflectance from human tissue has a great potential for wide acceptance. In our design, the light source and sensor are placed in a concave structure using the principle of reflective oximetry. In addition, the design is for wrist wearing as it is a more convenient and comfortable location than the finger for long duration measurement and continuous monitoring. It must be noted that for pulse and blood pressure monitoring, some products located at the wrist already exist in the market (e.g. Casio BP-100 and Omron HEM-608).

To summarize, our design has a novel sensor module design. A concave structure is designed to house the sensor module components so as to obtain improved operational efficiency when collecting the wrist pulse signals. In order to obtain desirable wrist pulse signals, the sensor module is designed to be placed at an inner part of the wrist. The special design of its concave shape helps the sensor module to stay in the chosen location of the wrist. The device has a very simple hardware structure without even a display because all data further processing, calculations and display will not be carried out on the wearable wrist device. A wireless transmission module will transmit all sensor data to an application of a nearby smart phone, which would perform all those tasks. Hence, the device can communicate in a cordless manner with a remote monitoring system. The radio interface can use the Bluetooth protocol.

III. PRINCIPLE OF OPERATION OF REFLECTIVE OXIMETRY

The scattering coefficient is much bigger than the absorption coefficient for most human tissue. Therefore, it is possible to build a model where the photon movement in the body tissue can be considered as a diffusion process, when the

geometric dimension is bigger than the scattering length, and then the photon will mainly scatter before it get sized by the photo-transistor. Therefore, light through wrist tissue can be described by photon diffusion equation [8]:

$$\frac{1}{c} \frac{\partial}{\partial t} \vartheta(r, t) - D \nabla^2 \vartheta(r, t) + \mu_a \vartheta(r, t) = S(r, t) \quad (1)$$

where $\vartheta(r, t)$ is the fluence rate, which represents the effective photon density at the position r and at time t . D denotes a diffusion coefficient, μ_a represents absorption coefficient of the tissue and $S(r, t)$ represents the light source.

Hence, the density of the photon reflecting from the body tissue is determined by the flux of the illumination and the detected light intensity. The equation of the density of the photon reflected is [8]:

$$R(\rho, r, t) = (4\pi Dc)^{-3/2} Z_0 t^{-5/2} \exp(-\mu_a c t) \exp\left(-\frac{\rho^2 + z_0^2}{4Dct}\right) \quad (2)$$

When time is long enough, the change ratio of reflected light intensity will be close to $-\mu_a c t$, as below:

$$\lim_{t \rightarrow \infty} \frac{\partial}{\partial t} \ln R(\rho, r, t) = -\mu_a c t \quad (3)$$

As a result, the change ratio of reflected light intensity $W = I_{AC}/I_{DC}$ is proportional to the absorption coefficient of the tissue. The AC part of the signal represents absorption of fluctuating wave of pulsing blood, while the DC part represents absorption of human tissue and vessel.

The absorption of red and infrared light by oxygenated hemoglobin (HbO₂) and reduced hemoglobin (Hb) is much bigger than that by other human tissue or water. Besides at different wavelengths, the light absorbance of HbO₂ and Hb are different. By this principle, we can deduce the oxygen saturation from the different ratio of reflective light intensity rate when two light with different wavelengths go through vessel blood inside human tissue [7], [8].

$$\begin{aligned} SpO_2 &= \alpha - \beta \frac{w_{\lambda 1}}{w_{\lambda 2}} = \alpha - \beta \frac{I_{AC}^{\lambda 1}/I_{DC}^{\lambda 1}}{I_{AC}^{\lambda 2}/I_{DC}^{\lambda 2}} \\ SpO_2 &= \alpha - \beta R \end{aligned} \quad (4)$$

where R is defined as follows:

$$R = \frac{I_{AC}^{\lambda 1}/I_{DC}^{\lambda 1}}{I_{AC}^{\lambda 2}/I_{DC}^{\lambda 2}}$$

and α, β are parameters that need to be determined experimentally. Hence, when the values of the DC and AC component of the red and infrared light intensity are obtained, the blood oxygen saturation can be calculated.

Equation (4) has assumed a linear relationship between oxygen saturation and the R value, which is commonly used in the field and in the market products. Yet, considering the differences in light intensities between red and infrared light, it is also reasonable to state a second-order relationship between R and the oxygen saturation:

$$SpO_2 = \alpha - \beta R - \gamma R^2 \quad (5)$$

The parameters α , β and γ can be determined in an experimental study. It can be shown that the second order equation can potentially provide a more accurate calculation for the value of oxygen saturation.

IV. SYSTEM DESIGN

Fig. 1 gives the overall system design of the reflective oximeter, which consists of Concave Sensor Module, Signal Processing Module, A/D Converter Module, Wireless Transmission Module and Smart Phone.

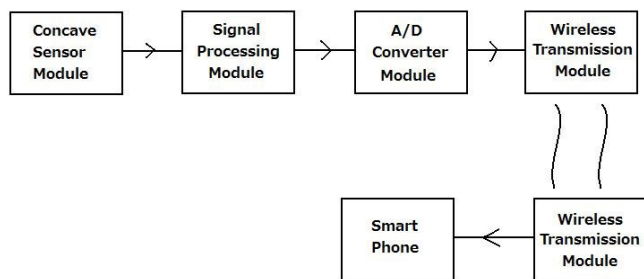

FIGURE 1. System design diagram.

The Concave Sensor Module is used to acquire the original light signal reflected from fluctuating blood and tissue. In the Signal Processing Module, the original signal is separated into a DC and AC component.

In the A/D converter Module, the analog signal is transferred to the digital signal by sampling and regulating. This is because the digital signal is easier to be transferred by wireless transmission module and more suitable for further processing and application.

The Wireless Transmission Module is made of a transmitter and a receiver, which would establish a communication link between the wrist band and the smart phone. Fig. 2 shows the wireless transmission of sensor data from the wrist worn pulse oximeter to the smart phone.



FIGURE 2. Wireless transmission of sensor data from the wrist pulse oximeter.

Further signal processing and computing are done in the application in the smart phone for saving hardware. The result can also be displayed by the smart phone and the data can be

stored inside the smart phone. As a result of using minimal hardware for the device and the use of a flexible software solution for handling the sensor data, the cost of device will be very low. In this paper, we focus on the description of the wrist concave sensor and the signal processing module.

V. CONCAVE SENSOR MODULE

As shown in Fig. 3 and Fig. 4, the concave oximeter sensor consists of a concave support structure, one red LED and one infrared LED and two photo-transistors.

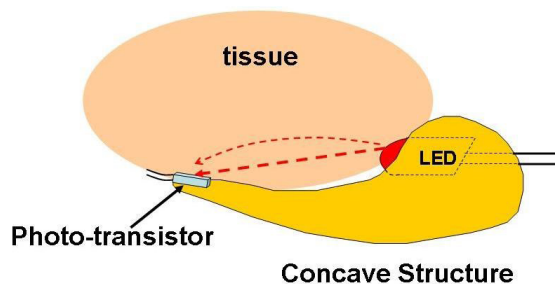

FIGURE 3. Section plan of Concave Sensor Module

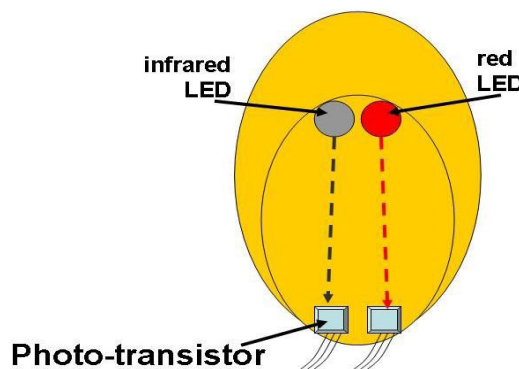

FIGURE 4. Top view of Concave Sensor Module.

The soft concave support structure matches with the convexity of the human wrist, with the two LEDs inside the pinhole. The two photo-transistors are placed on the other end of the structure at a suitable distance from the LEDs. The separation distance has been verified after many experiments.

The peak wavelengths of the red LED and infrared LED are 630nm and 880nm respectively, which are sensitive to the changes in oxygen saturation.

The photo-transistors are placed directly in contact with the skin and their flat surfaces would not cause any discomfort to the wrist. The photo-transistors have nearly the same spectral responsivity at wavelength of 630nm and 880nm, which would have the same the sensitivity for better accuracy.

The black cover wrist band attaches the structure to the wrist tightly to make it wearable, stable and comfortable, and also to reduce noise effect.

The implemented sensor after many testing experiments is shown in Fig. 5, and the sensor with further plan is shown in Fig. 6. At the moment, the wireless data transmission module has not been implemented yet.



FIGURE 5. Photo of the implemented sensor.

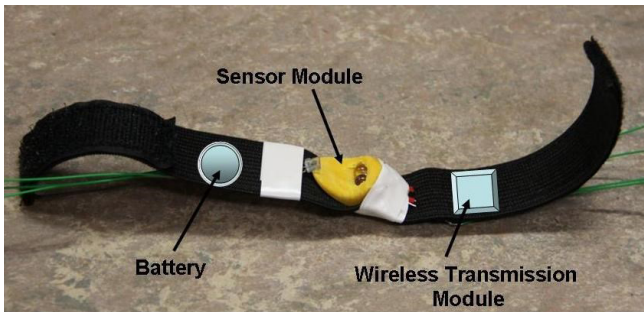

FIGURE 6. Photo of the sensor with further plan.

VI. SIGNAL PROCESSING MODULE

The Fig. 7 shows the diagram of the signal processing module consisting of pass filters and amplifiers, providing signal processing of wave filtering and amplifying. The received signal reflected from blood contains AC signal and DC signal, which are separated by the pass filters and then amplified respectively.

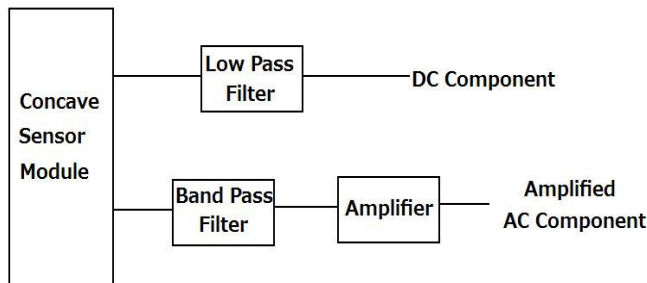

FIGURE 7. Diagram of signal processing module.

The DC Component is filtered by low pass filter (LPF). Circuit Diagram of low pass filter is shown in Fig. 8. The Corner Frequency of low pass filter is 0.16 Hz. As a result, the

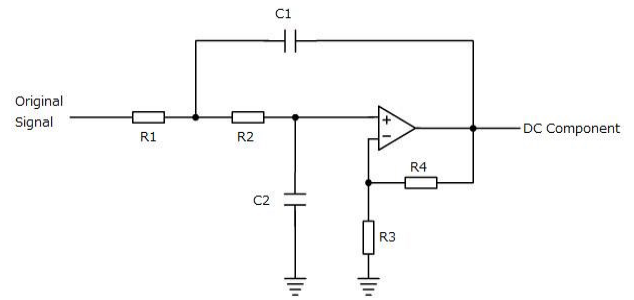

FIGURE 8. Circuit diagram of low pass filter.

LPF can filter fluctuating pulse wave (AC Component) and high frequency noise such as interference from daylight lamp and electromagnetic interference from power source.

The AC Component is through a band pass filter and an amplifier. Circuit diagram of Band Pass filter (BPF) and amplifier (shown with LED and Photo-transistor) is given in Fig. 9. The Center Frequency of the BPF is 1 Hz, which is close to the normal pulse frequency of a person. As a result, the BPF can filter the signal that is caused by light going through the body tissue and vein (DC Component) as well as high frequency noise such as interference from electromagnetic interference from power source and daylight lamp. As the AC component of the signal is too small (about 1 mV), an amplifier is used to amplify it for further processing.

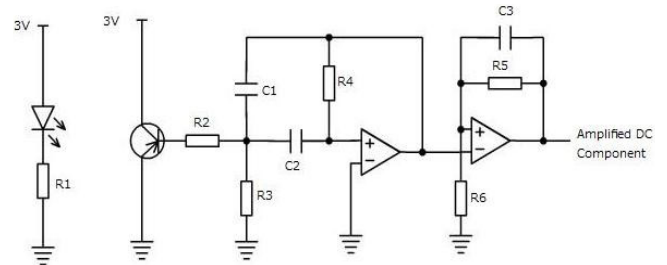

FIGURE 9. Circuit diagram of band pass filter and amplifier (shown with LED and photo-transistor).

The AC and DC signals of red and infrared light are used together to compute the oxygen saturation by equation (4). The computation can be carried out by the application inside a smart phone.

The AC signal is also used to obtain the pulse waveform. By calculating the cycle of pulse waves, we can get the heart rate. The AC signal presenting the pulse wave has other values of further medical research, which can be developed by other applications in the smart phone.

VII. SYSTEM IMPLEMENTATION AND EXPERIMENTAL RESULTS

In Fig. 10, the overall system implementation is shown. The supply voltage to the prototype is 3V.

The experimental results of the AC pulse signals obtained by red LED and infrared LED are shown

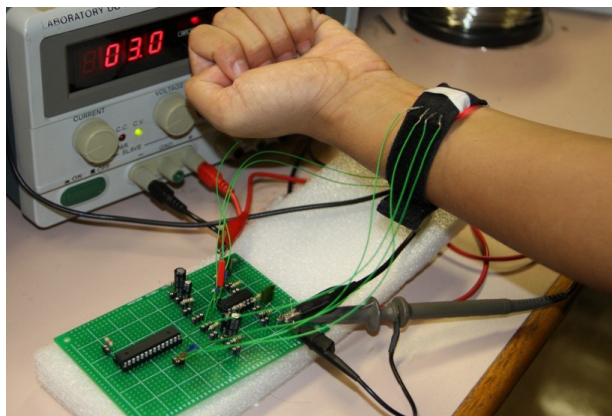

FIGURE 10. The photo of the overall implementation.

in Fig. 11 and Fig. 12 respectively. A section of the recorded data verses time are shown. The two recorded photoplethysmograms both display the cardiovascular cycle clearly.

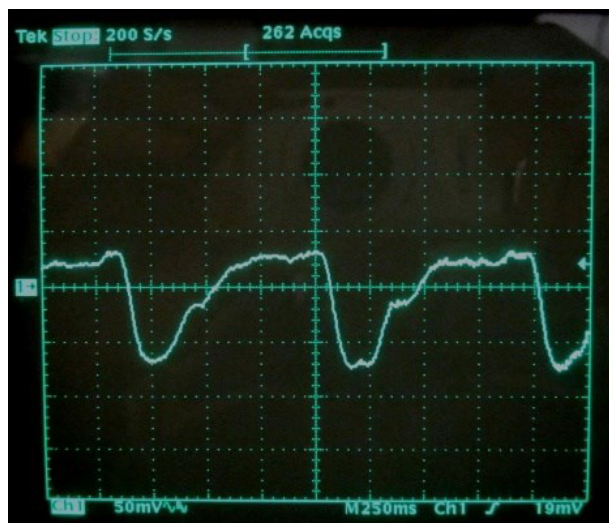

FIGURE 11. The pulse signal obtained by the red LED.

Figure 11 shows the initial pulse wave signal after filtering. The system has detected the pulse wave signal efficiently, which indicates that the incident light can indeed visit the arterial vessel. The DC components and the AC components of the red and infrared light intensity can be obtained with proper processing of the signals. The oxygen saturation can then be calculated by the ratio of the light intensity change rates under the two different wavelengths.

The calibration of an oxygen oximeter can be a complicated task. Experimental procedures are used to obtain the parameters required in equations (4) and (5). An oxygen saturation simulator is used and by doing some experiments, data relating the oxygen saturation and the R values are obtained. The Index 2XL SpO₂ simulator by Fluke Biomedical [12] has been used. Figure 13 shows the empirical R to oxygen saturation curve under the linear and quadratic relationships.



FIGURE 12. The pulse signal obtained by the infrared LED.

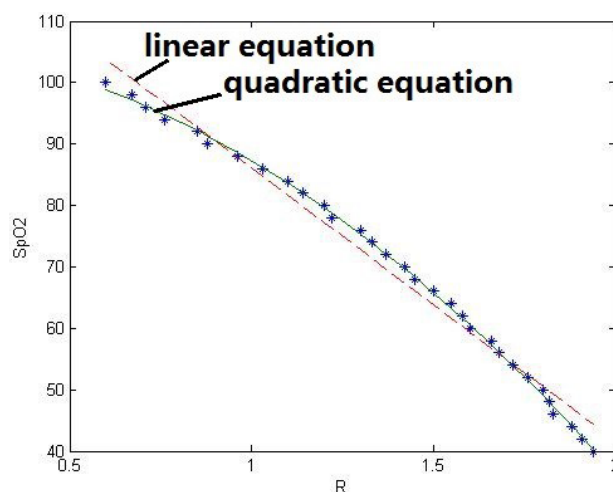

FIGURE 13. The R curve modeled by two relationships.

In the calibration process, the linear equation becomes

$$SpO_2 = 130.4 - 44.4 R$$

If modeled by second-order, the quadratic equation is

$$SpO_2 = 106.9 - 3.9 R - 15.6 R^2$$

It can be seen that the quadratic (second-order), nonlinear relationship can provide a better fit with the data.

VIII. CONCLUSIONS

This paper describes the development of a new kind of wrist pulse oximeter. It is different from the conventional finger pulse oximeter due to the following reasons:

1. The device has a novel design of the sensor module. The optical source has two LEDs (red and infrared). The receiver is consisted of two photodiodes. A new optical structure is designed to house the sensor module components so as to

obtain improved operational efficiency when collecting the wrist pulse signals.

2. The location in the wrist for placing the sensor module of the pulse oximeter is also unique. In order to obtain desirable wrist pulse signals, the sensor module is designed to be placed in an inner part of the wrist. The special design of its concave shape helps the sensor module to stay in the chosen location of the wrist.

3. The device is a genuine wrist pulse oximeter as opposed to the usual finger pulse oximeter. It has a very simple hardware structure without even a display because all data processing, calculations and display will not be carried out on the wearable wrist device.

4. During the calibration process, it is found that a second-order relationship between the R value and the oxygen saturation can provide a better fit with the data.

In the future, a Bluetooth module can be developed to transmit all sensor data to an application of a nearby smartphone, which would perform all those tasks. As a result of using minimal hardware for the device and the use of a flexible software solution for handling the sensor data, the cost of device will be very low. It is expected that the final cost can be only around a fraction of the cost of a typical finger oximeter in the market.

REFERENCES

- [1] I. Sarussi, "Device for use with reflective pulse oximetry," U.S. Patent 20070038050, Feb. 15, 2007.
- [2] Y. Mendelson and B. D. Ochs, "Noninvasive pulse oximetry utilizing skin reflectance photoplethysmography," *IEEE Trans. Biomed. Eng.*, vol. 35, no. 10, pp. 798–805, Oct. 1988.
- [3] Y. Mendelson, J. C. Kent, B. L. Yocum, and M. J. Birlle, "Design and evaluation of a new reflectance pulse oximeter sensor," *Med. Instrum.*, vol. 22, no. 4, pp. 167–173, Aug. 1988.
- [4] Y. Mendelson and C. Pujary, "Measurement site and photodetector size considerations in optimizing power consumption of a wearable reflectance pulse oximeter," in *Proc. 25th Annu. Int. Conf. IEEE Eng. Med. Biol. Soc.*, Sep. 2003, pp. 3016–3019.
- [5] Y. Mendelson, C. Pujary, and M. Savage, "Minimization of LED power consumption in the design of a wearable pulse oximeter," in *Proc. IASTED Conf. Biomed. Eng.*, 2003, pp. 249–254.
- [6] H. Santha, N. Stuban, and G. Harsanyi, "Design considerations of small size reflective type pulse oximeter heads in special applications," in *Proc. 1st Conf. Electron. Syst. Integr. Technol.*, Sep. 2006, pp. 404–408.
- [7] G. Di, X. Tang, and W. Liu, "A reflectance pulse oximeter design using the MSP430F149," in *Proc. IEEE/ICME Int. Conf. Complex Med. Eng.*, May 2007, pp. 1081–1084.

- [8] Q. Cai, J. Sun, L. Xia, and X. Zhao, "Implementation of a wireless pulse oximeter based on wrist band sensor," in *Proc. 3rd Int. Biomed. Eng. Inform. (BMEI)*, Oct. 2010, pp. 1897–1900.
- [9] S. B. Duun, R. G. Haahr, K. Birkelund, and E. V. Thomsen, "A ring-shaped photodiode designed for use in a reflectance pulse oximetry sensor in wireless health monitoring applications," *IEEE Sensors J.*, vol. 10, no. 2, pp. 261–268, Feb. 2010.
- [10] K. Li and S. Warren, "A wireless reflectance pulse oximeter with digital baseline control for unfiltered photoplethysmograms," *IEEE Trans. Biomed. Circuits Syst.*, vol. 6, no. 3, pp. 269–278, Jun. 2012.
- [11] T. Zaman, P. A. Kyriacou, and S. K. Pal, "Free flap pulse oximetry utilizing reflectance photoplethysmography," in *Proc. 35th Annu. Int. Conf. IEEE Eng. Med. Biol. Soc. (EMBC)*, Jul. 2013, pp. 4046–4049.
- [12] (2007). *Fluke Biomedical*, Cleveland Calibration Lab., Cleveland, OH, USA. [Online]. Available: <http://assets.fluke.com/manuals/index2xlumeng0000.pdf>, accessed Dec. 12, 2014.



GRANTHAM PANG received the Ph.D. degree from the University of Cambridge, Cambridge, U.K., in 1986. He was with the Department of Electrical and Computer Engineering, University of Waterloo, Waterloo, ON, Canada, from 1986 to 1996, and then joined the University of Hong Kong, Hong Kong. Since 1988, he has authored over 70 journal papers and 120 international conference papers. He holds five U.S. patents, one European patent, and one Chinese patent.

His research interests include biomedical informatics, visual surveillance, machine vision for surface defect detection, optical communications, logistics, intelligent control, and expert systems.



CHAO MA received the M.Sc. degree in electrical engineering from the University of Hong Kong, Hong Kong, in 2014. He is currently with Valeo Inc., Troy, MI, USA. He was with Dr. Pang in the design of the neo-reflective wrist pulse oximeter in 2011, and then with Dr. Hofmann in the design of maximum power point tracking circuit for solar panels and energy harvesting backpacks in 2013 and 2014. His current research interests are in lidar, active safety, auto-parking,

and auto-driving.

• • •