

**REPORT OF WORK ON ANKYLOSING SPONDYLITIS**  
**IN HONG KONG 1982 – 1985**

**Dr. Eric Ho**  
**Department of Orthopaedic Surgery**  
**University of Hong Kong**  
**Queen Mary Hospital**  
**Hong Kong**

UNIVERSITY OF HONG KONG  
LIBRARY

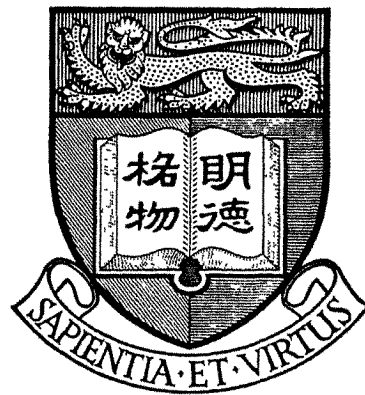

*This book was a gift  
from*  
Hong Kong Society for Rehabilitation

<b>INDEX</b>	<b>Page</b>
<b>I. Foreword (M.B.LEE)</b>	
<b>Preface (E. Ho)</b>	
<b>II. Medical and Surgical Aspects</b>	
A. Clinical review of 100 cases of ankylosing spondylitics in Hong Kong Chinese (E. Ho, L.C.S. Hsu, S.P. Chow, J.C.Y. Leong)	1
B. HLA B27 testing in Hong Kong Chinese (E. Ho, S.C.F. Yuén, L.C.S. Hsu, S.P. Chow, J.C.Y. Leong)	7
C. Total Hip arthroplasty in Ankylosing Spondylitis – A Review of 40 Cases (E. Ho, D. Fang, L.C.S. Hsu, J.C.Y. Leong)	11
D. Radiological study of the Ossification Pattern in the Spine affected by Ankylosing Spondylitis (E. Ho, F. L. Chan, L.C.S. Hsu, J.C.Y. Leong, A.C.M.C. Yau)	19
E. Radiological Study of Spinal Pseudoarthrosis in Ankylosing Spondylitis (F. L. Chan, E. Ho, L.C.S. Hsu, D. Fang, J.C.Y. Leong)	23
F. Family Screening in Ankylosing Spondylitis in Hong Kong Chinese (E. Ho)	35
G. Neurological Complications in Ankylosing Spondylitis	37
i) Cauda Equina Syndrome (E. Ho, M. Yuen, L. Ma, L.C.S. Hsu)	
ii) O.P.L.L. and A.S. with traumatic tetraparesis (E. Ho, J.C.Y. Leong).	
<b>III. Paramedical Management Review</b>	
A. Occupational therapy in Ankylosing Spondylitics (K. Chan, E. Ho)	47
B. Physiotherapy in Ankylosing Spondylitics (D. Wong, J.M. Bourne, E. Ho)	51
C. Medico-Social Problems in Ankylosing Spondylitics (R. Leung, P. Leung, E. Ho)	53
D. Clinical Psychological Problems in Ankylosing Spondylitics (P. Leung, P. Lee, F. L. Mak, E. Ho)	57
E. Study on Pain in Ankylosing Spondylitics (C. Hsu)	65
<b>IV. The Ankylosing Spondylitis PHAB Club in Hong Kong (M. B. Lee, E. Ho)</b>	<b>115</b>
<b>V. The Future of Ankylosing Spondylitics in Hong Kong (E. Ho)</b>	<b>117</b>

Manuscript IIID had been published in the Journal of the Hong Kong Psychiatric Association.

Manuscripts IIA, IIB, IID had been published/accepted for publication in the Journal of Western Pacific Orthopaedic Association.

Manuscript IIG (ii) had been accepted for publication in Spine.

Permission had been obtained from the publishers to include these manuscripts in this report.

## FOREWORD

It is my honor as Chairman of the Hong Kong Society for Rehabilitation and also President of the Ankylosing Spondylitis Phab Club to introduce to you this report on researches on Ankylosing Spondylitis in Hong Kong.

The inception of the MacLehose Medical Rehabilitation Centre in December 1984 represents not only an important milestone in the history of the Hong Kong Society for Rehabilitation but also a new commitment of the Society towards local research efforts in the field of rehabilitation. I am most pleased that Dr. Eric Ho has kindly accepted to shoulder the arduous task, under the sponsorship of the MacLehose Medical Rehabilitation Centre, to compile this very useful documentation of studies on patients suffering from Ankylosing Spondylitis in our community. This is, I believe, the first comprehensive review on the subject covering the medical, surgical, para-medical, social and psychological aspects of local Chinese Ankylosing Spondylitis patients. Some of the findings have important bearing on the needs of this often neglected sector of our society. I sincerely hope the Report would not only arouse the interest and attention of the related professionals, policy makers and concerned parties, but also stimulate further researches in this area.

May I take this opportunity to thank Dr. Ho for his dedication and hardwork without which the Report could not have been realized. I would also like to thank all the contributors to the Report for their insight and efforts which I am sure would bring more hopes to our Ankylosing Spondylitis patients in Hong Kong.

M. B. Lee  
Chairman  
Hong Kong Society for Rehabilitation

15th April, 1986



## PREFACE

Ankylosing spondylitis is a unique entity. It falls into the territory of rheumatologists, orthopaedic surgeons, immunologists, physiotherapist, occupational therapists, social workers and psychologists. The multi-faceted nature of the spondylitics had been fairly neglected. Research into the pathogenesis of this condition is the first step towards the understanding and proper management of this disease. Thanks to the conjoined effort of the immunologists and the rheumatologists in this aspect.

However, the other studies of the disease is still rudimentary, especially in the Oriental areas. Very often the patient is seen late with unremitting pain and deformities.

From 1982, work was started in the Duchess of Kent Children Hospital to look into this problem. An attempt is made to centralise these patients at all stages of the disease. This would enhance proper management, allow research and improve the morale of those affected. In October 1983, the Ankylosing Spondylitis P.H.A.B. club was founded.

This report composes the work done on the spondylitis since 1982.

I must thank all the contributors in making this work feasible. My cordial thanks should also be shared by the Hong Kong Society for Rehabilitation, without whose help the edition of this report is impossible.

I do hope this work shall perpetuate, for the many more years to come.

Eric Ho,  
Lecturer  
Department of Orthopaedic Surgery,  
University of Hong Kong,  
1985

# ANKYLOSING SPONDYLITIS – CLINICAL SURVEY IN 100 CONSECUTIVE CASES IN HONG KONG CHINESE

E. K. W. HO, M.B.B.S., F.R.C.S. (Glas)

\*L. C. S. HSU, M.B.B.S., F.R.C.S. (Edin), F.A.C.S.

\*S. P. CHOW, M.B.B.S., F.R.C.S. (Edin)

\*\*J. C. Y. LEONG, M.B.B.S., F.R.C.S. (Ed.)  
F.R.C.S. (Eng)

Department of Orthopaedic Surgery,  
University of Hong Kong,  
Queen Mary Hospital  
Hong Kong.

Lecturer, Department of Orthopaedic Surgery, University of Hong Kong.

\* Senior Lecturer, Department of Orthopaedic Surgery, University of Hong Kong.

\*\* Professor & Head, Department of Orthopaedic Surgery, University of Hong Kong.

## INTRODUCTION

Ankylosing spondylitis is a fairly well documented clinical entity in the Caucasians. However there is a slight but definite ethnic difference concerning its clinical features. (1) Extensive studies on this disease in the Chinese population is still lacking. It is the aim of this paper to analyse the result of a cross sectional study of the clinical features in 100 consecutive cases of ankylosing spondylitis in the Hong Kong Chinese population. This will form the basis of future study on this disease in our population. Certain features showing ethnic differences were found and their significance discussed.

Ankylosing spondylitis is a chronic progressive arthritis. It affects principally the sacroiliac joints. This is followed later by spinal apophyseal joints, the hip joints and sometimes peripheral joints. The patients with ankylosing spondylitis often present to the orthopaedic surgeons with backache and periarticular symptoms. This may render diagnosis difficult especially if the symptoms are mild. This paper will present the clinical features of 100 consecutive ankylosing spondylitis patient in the Hong Kong Chinese population.

**KEYWORDS** – clinical features – ankylosing spondylitis – Hong Kong Chinese.

## MATERIALS AND METHODS

100 consecutive ankylosing spondylitis patient all fulfilling the New York Criteria (2) were studied. Their daily activities and problems with work were studied. Clinical symptoms concerning the nature of the pain, stiffness experienced, chest problem, peripheral joint affection and systemic

manifestations were all recorded in details. Individual physical examination included estimation of spinal movement, detecting involvement of sacro-iliac joints and hips, chest expansion measurement and affection of posture and gait. All had HLA-B27 testing using the Terasaki's lymphocytotoxicity Micro droplet method.

## RESULTS

Among the 100 cases surveyed, 87 were male and 13 female. 20 patients were involved in work as heavy labourers while the rest were involved in relatively lighter duties. Detailed questioning showed that 26 had recent change in their nature of job as a result of the disease in the recent 5 years. 78 patients were involved in at least one constant sport activity. The average age of the patient is 32 (range 17 to 61).

The initiation of this disease is centrifugal if patient noticed peripheral joint involvement prior to spine and sacroiliac joint symptoms. Contrary it is centripedal if the first symptom was experienced in the sacro-iliac joint or low back. 28 cases developed their disease in centrifugal fashion while the rest is centripedal.

The location of the pain depends on the stage of involvement of the skeletal system. The distribution on first interview is tabulated in Fig. I.

	<u>No. of Patients</u>
Buttock	18
Low Back	45
Dorsal Lumbar Junction	10
Whole spine	3
Other combinations	<u>24</u>
	100

(Fig. 1)

The nature of pain experienced is analysed and the result shown in Figure 2.

<u>Nature of Pain</u>	<u>No. of Patients</u>
Transient	58
Persistent	40
Unknown	<u>2</u>
	100

(Figure 2)

Detailed descriptions of the character of pain they experienced are shown in (Fig. 3, 4, 5, 6.)

<u>Character of Pain</u>	<u>No. of Patients</u>
Vague	36
Localised	60
Unknown	<u>4</u>
	100

(Figure 3)

<u>Localization of Pain</u>	<u>No. of Patients</u>
Unilateral	9
Bilateral	90
Unknown	<u>1</u>
	100

(Figure 4)

<u>Severity of Pain</u>	<u>No. of Patients</u>
Mild	22
Moderate	61
Severe	16
Unknown	<u>1</u>
	100

(Figure 5)

<u>Radiation of Pain</u>	<u>No. of Patients</u>
Up to neck	25
Down to buttock	16
No radiation	<u>59</u>
	100

(Figure 6)

Early morning stiffness is one of the hall mark in ankylosing spondylitis. It is present in 69 patients of which 50 still had relatively mobile spine. The location of stiffness experienced, is commonest over the lumbar region – see Fig. 7.

<u>Site</u>	<u>No. of Patients</u>
Hip joint	1
Lumbar Spine	61
Dorsal spine	1
Cervical spine	5
Whole spine	10
Other combination	8

Unknown	<u>14</u>
	100

(Figure 7)

The severity of stiffness is graded into mild, moderate and severe. It is represented in Figure 8.

<u>Nature of Stiffness</u>	<u>No. of Patients</u>
Mild	30
Moderate	39
Severe	19
Unknown	<u>12</u>
	100

(Figure 8)

Exercise is helpful in relieving stiffness in 79 cases in our study.

Sternal discomfort is a fairly common complaint in our series. It is present in 52 cases. Significant limitation of exercise tolerance due to the disease affecting chest expansion is present in 11 cases. Active pulmonary tuberculosis is present in 7 cases and recurrent chest infection in 2 patients. The chest expansion is measured at the nipple level in male and below the breast in female. It averages 2.5 cm.

The pattern of peripheral joint involvement is also studied. 58 patients had peripheral joint involvement during the course of their disease. There is significant variation in the pattern of peripheral joint involvement as the disease progress. The distribution is shown in Figure 9.

<u>Peripheral Joint Involvement</u>	<u>No. cases</u>
Hip	27
Knee	38
Ankle	12
Heel	11
Shoulder	14
Elbow	1
Wrists	2

(Figure 9)

Systemic complaints included: 6 cases with analgesic induced gastro- intestinal bleeding and 1 case of aplastic anaemia induced by phenylbutazone treatment. 2 cases had persistent diarrhea but only 1 had sigmoidoscopic features of ulcerative colitis. None of the patients in this series had significant genito urinary symptoms. 11 cases had uveitis of whom 2 were female patients. 3 cases had cardiac symptoms attributed to by ankylosing spondylitis but only 1 had demonstrable aortic incompetence by echo cardiography. 10 cases had skin problems all seen by dermatologists but only 3 had clinical features of psoriasis.

Measurement of lumbar spine movement is fairly inaccurate due to variation produced by pain, patient cooperation and inter-observers errors. No attempt is made to quantify this in our study. However on clinical testing, the lumbar spine movement is completely obliterated in 31 cases while the rest had some observable movement. Of these 31 cases, only 2 were female. The sacro-iliac joints were examined by forceful compression and distraction of the pelvis together with reproduction of local tenderness. It is unilaterally positive in 7 cases and bilaterally present in 14 cases. The hip movements were tested and 28 cases had definite limitation. All these 28 cases had bilateral limitation (including those with total hip replacements). Abnormalities in posture are represented by loss of normal lumbar lordosis with or without a round thoracic spine. The head and neck assumes a forward posture. This is present in 53 patients. 28 patients walk with a wide base gait, among which 20 cases had hip involvement. 9 patients had hip replacement for either ankylosis or severe painful hip. 1 patient had spinal osteotomy for severe thoracolumbar kyphosis. 9 cases had to resort to external aid for proper-ambulation of whom 6 had previous hip operations. All these 6 cases had stiff lumbar and cervical spine. 1 case had a concomittant hemiplegia after a traffic accident, another case had severe peripheral joint involvement requiring external aid. 1 patient required a stick because of senility and poor vision.

## DISCUSSION

Ankylosing spondylitis is essentially a disorder of young male adults. Figures in different series vary from around 10:1 to 2:1. This ratio depends on patient selection. Our present survey showed a male preponderance of 6.7:1. This figure is fairly close to Ansell's finding (3) of 5:1 male to female ratio in her early cases of juvenile ankylosing spondylitis under the age of 16. Probably this indicates a sufficient random series in our patient currently being studied. The disease is said to be symptomatically milder in female. This is substantiated in our study. Of the 31 cases having clinically completely ankylosed spine, only 2 were female. All the other female patients have xray changes confined mostly to the sacroiliac joints only. Taking complete ankylosis as a parameter of disease severity, it is clear that the male sex has a higher chance of suffering from more severe disease. However analysis of these 31 cases showed that the average age of the 2 sexes are comparable, so is the duration of disease. It seems the male sex had only a higher chance of severe disease development but those who are prone to severe ankylosis of the spine does so deposite sex. Tyson et al (4) stressed the more

frequent involvement of the cervical spine in females but this had not been our experience.

It is said that ankylosing spondylitis usually carries a good prognosis and over 80% of the patients (5) remains capable of full working and domestic duties. 26% of our cases had to change the nature of their jobs in the recent 5 years. All these 26 cases had relatively severe disease and 20 of them had significant stiffness of their spine while the other 6 cases had uncontrolled disease activities prior to be seen by us. It is obvious that if the disease is properly controlled at an early stage, the patients are fully capable of normal daily work and activities.

In a study (6) of 184 patients with ankylosing spondylitis, 91 (49.4%) of them had initial symptoms of buttock and low back aches. However, pain affecting the other joints in the body presenting as the initial symptom is present in 39 cases (21%). 28 cases (28%) of our current series had initial symptom affecting more peripheral joints prior to spinal involvement. Ankylosing spondylitis is certainly an important differential diagnosis in a patient with peripheral arthropathy. In this cross sectional study, 63 patients (63%) present currently with either buttock or low back pain. This is similar to studies in the Caucasians (6) in that these 2 areas are mostly affected.

Polley (7) reported an incidence of 50% peripheral arthritis in ankylosing spondylitis. In our series 58 patients (58%) had peripheral arthritis during their course of disease. However only 1 case had permanent small peripheral joint deformity (Fig. 1). The pattern of peripheral joint involvement clearly indicates a lower limb preponderance. Usually the more proximal joints are involved, i.e. hip, knee and shoulder.

The nature of pain experienced by ankylosing spondylitics is fairly distinct from other spinal affections namely disc prolapse, trauma, infection or hysteria. Of the 40 patients having persistent pain, a great majority of them had significantly severe disease in the form of ankylosis of the spine (25 cases) while those 58 cases with transient form of pain had less incidence of complete ankylosis (6 cases). This indicates that the pain initially was transient but with time, it assumes a more persistent form (6). 60 cases had localization of their pain and it is nearly equally shared between the area in the buttock and the low lumbar spine. Most of the pain experienced by them is bilaterally represented (90%). The severity of pain they experienced is never quite comparable to that of disc prolapse, trauma or infection. Only 16 cases (16%) had very severe degree of pain. Unlike pain arising from a disc prolapse, our patients experienced little radiation of their pain (59%) and

none of our patients had sciatica like complaint which is claimed to be rare (5% in Harts series (6)).

Early morning stiffness is common in our series (69%). This sense is more common in those patients with relatively unankylosed spine (50 cases). Probably in patients with significantly ankylosed spine, they are accustomed to the stiffness and there is no significant disturbance they could notice after a period of rest. On the contrary, patients with relatively mobile spine are greatly incapacitated after a period of immobilization and 50 cases experienced this discomfort. Moreover, 79 cases (79%) claimed definite benefit from exercises in relieving stiffness. The 21 cases whose subjective stiffness persist after exercises all had severely ankylosed spine. All these point to the importance of early exercises in the unankylosed spine in prevention of permanent stiffness or deformity. The stiffness like the pain is experienced mostly in the lumbar region (61%) and severe stiffness occurs mostly in male patients. Of the 19 cases having subjectively severe stiffness of their back, 2 were female patients and these 2 on clinical assessment were shown to have completely ankylosed lumbar spine.

Sternal discomfort is common in our series (52%). 40 of these 52 patients still had a relatively mobile lumbar spine. It seems sternal discomfort is a fairly significant early complaint.

As active pulmonary tuberculosis is still rife in Hong Kong it is not surprising to find 7% of our patients complicated by this (Figure 2). On a separate review of 50 sets of chest roentgenograms in ankylosing spondylitics, another 7 cases had features of apical pulmonary fibrosis suggesting previous pulmonary tuberculosis.

Patients with ankylosing spondylitis may have systemic upsets. It is clear that such association is less common in the Chinese population under study. Ulcerative colitis is notoriously rare in our popula-

tion. It is present only in 1 patient. 11 cases in our series had uveitis. This is low compared with Caucasian who had 1/3-1/5 of patients with ankylosing spondylitis having uveitis at some time in the course of the disease. Similarly aortic incompetence is rare. Psoriasis is also an uncommon association comparing with the Caucasian (8).

Localising tenderness over sacro-iliac joint is notoriously misleading (9). Of all the 3 methods we used namely forceful compression, distraction of the pelvis and local tenderness, no correlation with xray changes could be obtained. We believe that taking a simple antero-posterior xray of the pelvis is much simpler and more reliable than all the these manouvres in detecting sacro-iliac joint pathology in ankylosing spondylitis.

Affection of the hip is important in production of poor gait. It is also an important reason for requiring external aids in walking especially in patient with severe hip and spine ankylosis.

## SUMMARY

A cross sectional study on the clinical features in 100 Chinese patients suffering from ankylosing spondylitis had been performed. The clinical features of this disease is fairly identical between the Chinese and the Caucasians. However there is significant difference in the extend of association with systemic complications arising. This aspect is especially worth looking into. Hopefully by this we can elucidate clearly the true nature of ankylosing spondylitis and the associated conditions.

## LEGEND

1. Figure showing permanent peripheral joint involvement in patient with ankylosing spondylitis.
2. Chest xray showing concomittant tuberculosis.

## REFERENCE

1. Moll, J., *Ankylosing Spondylitis*. Churchill Livingstone, 1980.
2. Bennett, P.H., and WOOD, P.H.N. (1968), *Population Studies of the Rheumatic Diseases, Proceedings of the 3rd International Symposium, New York, 1966, Amsterdam: Excerpta, Medica*.
3. Ansell, B.M. (1978), *Chronic Arthritis in Childhood. Annals of the Rheumatic Disease* 37, 107.
4. Tyson, T.L. Et al (1953), *Marie-Strumpell Spondylitis in Woman. Annals of the Rheumatic Disease*, 123, 40.
5. Hart, F.D., *Clinical features and Complications. Ankylosing Spondylitis edited by J. Moll Churchill Livingstone 1980*.
6. Hart, F.D., and MacLagan (1955), *Ankylosing Spondylitis. A review of 184 cases, Annals of the Rheumatic Disease* 14, 77.
7. Polley, H.F., (1955), *The Diagnosis and Treatment of Rheumatoid Spondylitis. Medical Clinics of North America* 39, 509.
8. Wright, V., *Relationships between Ankylosing Spondylitis and other spondarthritides. Ankylosing Spondylitis edited by J. Moll Churchill Livingstone 1980*.
9. Newton, D.L.R., (1957), *Discussion on the clinical and radiological aspect of sacroiliac disease, Proceedings of the Royal Society of Medicine*, 50, 850.

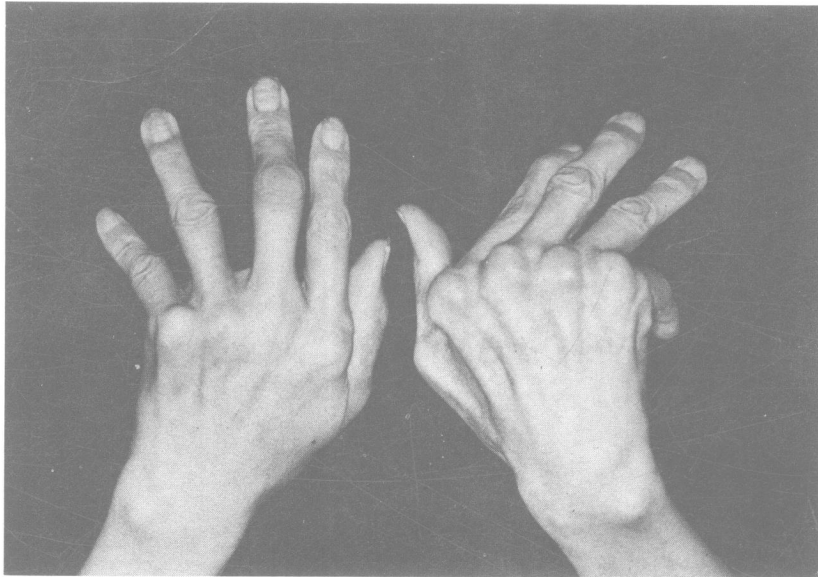

Legend 1A



Legend 1B

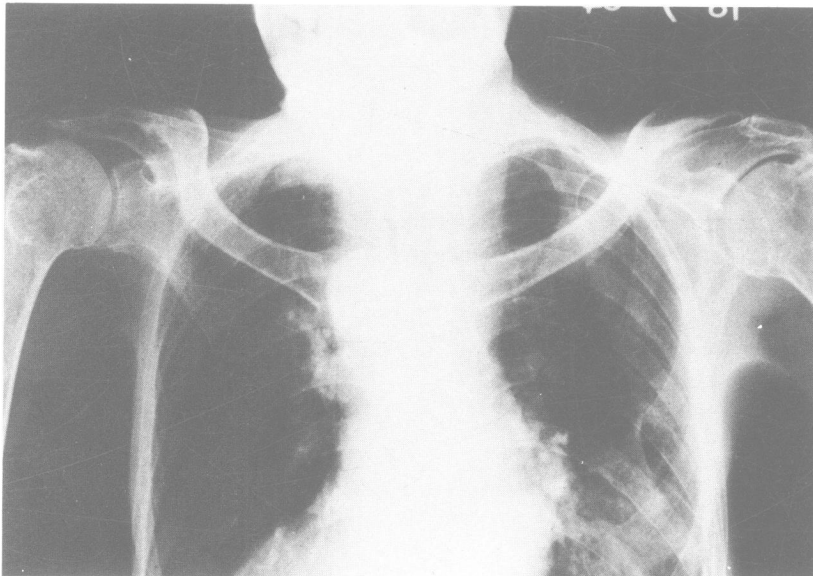

Legend 2



# HLA-B27 AN INDICATOR FOR ANKYLOSING SPONDYLITIS IN HONG KONG CHINESE

Eric K. W. Ho\*, Sydney C. F. Yuen, Louis C. S. Hsu\*,  
S. P. Chow\*, and John C. Y. Leong\*

## ABSTRACT

195 cases of ankylosing spondylitis (New York Criteria 1968) were tested for HLA B27 antigen and 192 cases were found to be positive. The incidence is 98.5%. At the same time 319 cases of selected control groups were tested for HLA B27 antigen. Only eleven of them gave positive results. The antigen frequency is 3.5%.

**Key Words** HLA B27 – Ankylosing Spondylitis – Hong Kong Chinese – Antigen frequency – Relative Risk.

## INTRODUCTION

Since Brewerton et al<sup>1</sup> and Schlosstein et al<sup>2</sup> first reported the high association of HLA B27 antigen (B27) with ankylosing spondylitis (AS) in Caucasian population subsequent workers in other countries have reported similar findings, such as Chan et al<sup>3</sup> of Singaporean Chinese, Sengupta et al<sup>4</sup> in Indian population and Shijimoto<sup>5</sup> in Japanese population. This association is substantiated for the first time in Hong Kong Chinese. The antigen frequency of B27 in Hong Kong Chinese is also established.

## MATERIALS AND METHODS

### Clinical materials

- (1) Selection of ankylosing spondylitics  
195 consecutive Chinese patients aged ranging from 14 to 49 who fulfilled the New York Criteria 1968 (Bennett and Wood) were typed for B27.
- (2) Control Groups
  - (a) 85 neonates from Hong Kong Sanatorium and Hospital were typed.
  - (b) 68 normal volunteers were typed.
  - (c) 166 in-patients without symptoms of low back pain with the diagnosis of trauma, fracture, scald and other surgical condition such as hernia were tested.

### Laboratory materials

All tests were performed by the Microdroplet lymphocytes cytotoxicity method (Terasaki).

## RESULTS

Among 195 ankylosing spondylitics, 192 were B27 positive. The incidence is 98.5%. In control group a, 2 infants were B27 positive among 85 consecutive infants tested. In control b, among 68 normal volunteers, 2 were B27 positive. In control group c, 7 were B27 positive out of 166 (Table 1).

The B27 antigen frequency is  $11/319 = 3.5\%$  ( $\chi^2 = 457.2, P < 0.0001$ ) and the relative risk is 1792.

The 'relative risk' (Woolf)<sup>6</sup> is calculated by the formula  $AD/BC$  where A and B are the numbers of ankylosing spondylitic patients with and without the antigen, and C and D are the numbers of controls with and without the antigen. The data suggest that B27 positive individuals are about 1792 times as likely to get the disease as B27 negative individuals.

## DISCUSSION

Our patients with AS showed striking correlation with B27, 192/195 (98.5%) of the patients were positive. This is higher than Chan et al's figure of 88% for Singaporean Chinese.<sup>3</sup> Our control groups gave comparatively low incidence of B27 (3.5%) which is close to B27 antigen frequency of Singaporean Cantonese group (3.0%)<sup>7</sup>. Cantonese is the major Chinese dialect speaking group in Hong Kong.

\* Department of Orthopaedic Surgery, University of Hong Kong, Queen Mary Hospital, Hong Kong.

\*\* The Duchess of Kent Children's Hospital at Sandy Bay, 12 Sandy Bay Road, Hong Kong.



**TABLE 1**  
*Results of test and control groups*

		B27 (+)	B27 (-)	Total	B27 (+) &
Test group	A.S.	192	3	195	98.5%
	(a) Neonates	2	83	85	
Control Group	(b) Volunteers	2	66	68	3.5%
	(c) In-Patients	7	159	166	

The 'relative risk' in disease development among B27 positive Hong Kong Chinese is 1792. This means that B27 positive individuals are about 1792 times as likely to get AS as B27 negative individuals. This is the highest relative risk ethnic group so far reported (Table 2).

If we apply our B27 antigen frequency and its association with AS in Hong Kong Chinese to calculate the 'predictive value of negative B27 for absence of AS' described by Hawkins<sup>8</sup> et al for an unselected population and assuming the prevalence of AS in the same as that of Caucasian (68 per 52,000)<sup>12</sup>, the value is 99.99% in Hong Kong Chinese. In other words, in an unselected Chinese

population, any individual with negative B27 has only minimal chance (< 0.01%) of getting the disease. Therefore, B27 test can be used by clinicians as an indicator to identify doubtful cases of AS in Hong Kong Chinese.

#### CONCLUSION

The striking association between B27 and AS in Hong Kong Chinese is the highest among all ethnic group so far reported and the antigen frequency of B27 in Hong Kong Chinese is comparatively low. This will facilitate the usefulness of B27 as a valuable indicator for Ankylosing Spondylitis.

**TABLE 2**  
*Distribution of B27 antigen frequency and AS association in some ethnic groups.*

Country/Ethnic Origin	B27 antigen frequency (%)	B27 (+)/AS Association (%)	Relative risk
UK/Caucasian (9)	7	81.1 - 96.3	Approx. 113
Japan/Japanese (5)	2.3	91.7	Approx. 469
Singapore/Chinese (3)	7.1	88	102
USA/American Blacks (10 - 11)	2	60	Approx. 74
Hong Kong Chinese	3.5	98.5	1792
India/North Indian (4)	3.33	94.1	Approx. 464

## ACKNOWLEDGEMENT

We would like to thank Miss M. N. Leung, Medical Laboratory Technician of the Duchess of Kent Children's Hospital at Sandy Bay for her

technical assistance. We would also like to thank Mr. K. C. Nip, Laboratory Superintendent of Hong Kong Sanatorium & Hospital for his arrangement of neo-natal blood samples.

## REFERENCES

1. Brewerton D. A. et al. : *Ankylosing Spondylitis and HL-A27 Lancet*, 1, 904, 1973.
2. Schlosstein L. et al. : *High association of an HL-A antigen, W27 with Ankylosing Spondylitis. New Engl. J. Med.*, 288, 704, 1973.
3. Chan S. H. : *In Pro. of D-Pen-HLA 1982 "Immunogenetics in Rheumatology: D-Penicillamine & Musculoskeletal Disease"*, Australian Rheumatism Association, Perth, Western Australia, April, 1982.
4. Sengupta et al. : *HLA-B27 in Ankylosing Spondylitis in India, Lancet*, 1 (8023): 1209, 1977.
5. 井弘：強直性脊椎炎とその類似疾患とHLA抗原 *Hoechst HLA information* No.7.
6. Woolf B. *On estimating the relation between blood groups and disease. Annals of Human Genetics*, 19, 251, 1955.
7. Chan S. H. et al. : *HLA Antigens in the three normal southern Chinese Dialect Group – Cantonese, Hokkiens and Teochow. Singapore Med. J.*, Vol. 20, No.2: 335 – 338, 1979.
8. Hawkins B. R. et al. : *Use of the B27 test in the Diagnosis of Ankylosing Spondylitis: a statistical evaluation. Arthritis and Rheumatism* Vol. 24, No. 5: 743 – 746, 1981.
9. Moll J. M. H. : *Ankylosing Spondylitis, Churchill Livingstone*, 1980.
10. Ruderman R. J. et al. : *HLA B27 in black patients with Ankylosing Spondylitis. Lancet*, 1, 610, 1977.
11. Kahn M. A. et al. : *HLA B27 in Ankylosing Spondylitis: differences in frequency and relative risk in American Blacks and Causansian, J. Rheumatol.* 3 (suppl.): 39-43, 1977.
12. Carter E. T. et. al. : *Epidemiology of Ankylosing Spondylitis in Rochester, Minnesota, 1935 – 1973. Arthritis Rheum* 22: 365 – 370, 1977.



**TOTAL HIP ARTHROPLASTY IN ANKYLOSING SPONDYLITIS**  
**A REVIEW OF 40 CASES**

**ERIC HO, F.R.C.S. (Glas.)**  
**DAVID FANG, F.R.C.S. (Ed), M. Ch. Orth. (Liverpool)**  
**LOUIS HSU, F.R.C.S. (Ed), F.A.C.S.**  
**JOHN LEONG, F.R.C.S. (Ed), F.R.C.S. (Eng.)**

*From* **Department of Orthopaedic Surgery,  
University of Hong Kong,  
Queen Mary Hospital  
Hong Kong.**

**ERIC HO**            Lecturer, Department of Orthopaedic Surgery,  
Queen Mary Hospital, Hong Kong.

**DAVID FANG**        Senior Lecturer, Department of Orthopaedic  
Surgery, Queen Mary Hospital, Hong Kong.

**LOUIS HSU**         Reader, Department of Orthopaedic  
Surgery, Queen Mary Hospital, Hong Kong.

**JOHN LEONG**        Professor, Department of Orthopaedic  
Surgery, Queen Mary Hospital, Hong Kong.

## ABSTRACT

Of sixty five total hip arthroplasties done in ankylosing spondylitis by us in the past thirteen years, forty hips could be evaluated one to thirteen years after surgery. Sixteen patients had bilateral hip arthroplasty while seven had unilateral surgery. One patient with bilateral hip arthroplasty required unilateral revision surgery eleven years after the initial operation.

Two patients with pain over the hip had radiological evidence of loosening of both components of the arthroplasty while a third had pain because of deep infection. The walking ability improved in fifteen patients. One patient remained static. Seven patients still required external aids for various reasons after the operation. Improvement in hip movement is present in twenty-nine hips while four hips had progressive limitation in range postoperatively.

Complications included four cases of infection (two superficial and two deep). Radiological loosening of the arthroplasty were present in six hips.

## INTRODUCTION

Hip involvement is common in ankylosing spondylitis. It often produces excessive pain and sometimes ankylosis. Moreover in ankylosing spondylitis, the spine is usually very rigid so that loss of hip movement is not compensated by movement of the spine. Cup arthroplasty for affected hip in ankylosing spondylitis gave disappointing results<sup>4</sup>. Girdle-stone operation produces unilateral shortening of the limb and some degree of instability. This is reserved as a salvage procedure nowadays. The total hip arthroplasty seems to give satisfactory relief of pain and restoration of function. However many reports on total hip arthroplasty in ankylosing spondylitis are included in the general category of rheumatoid affections<sup>2,6</sup> thus making analysis difficult. It is the aim of this paper to analyse the result of forty total hip arthroplasties performed in patients suffering from ankylosing spondylitis, in an attempt to elucidate the unique problems arising.

## MATERIALS & METHOD

Twenty three male patients with ankylosing spondylitis who underwent forty total hip arthroplasties during the 13 year period from 1972 – 1984 were available for final follow up at the Department of Orthopaedic Surgery, University of Hong Kong. All the patients were finally examined by one of the authors (Ho). Sixteen patients had bilateral total hip arthroplasty while seven had unilateral replacement. One patient who had bilaterally replaced hip required a revision on one side ten years after the initial operation. The indications for the hip arthroplasty are shown in Table 1.

The duration of hip symptoms prior to surgery ranged from one to 8.5 years with an average of 5.5 years. The mean follow up period was 4.6 years with a minimum of one year and maximum thirteen years. The mean age at follow up was twenty nine year with a minimum of 24.5 years and maximum of forty five years.

The types of total hip arthroplasty used in these twenty three patients are shown in Table 2.

All but one patient had a full course of supervised postoperative physiotherapy.

The results were analysed according to the Merle d'Aubique and Postal hip functional grading.

Special attention was paid to the detection of spinal pseudarthrosis and significant kyphotic deformities requiring spinal osteotomy.

Investigations included preoperative and postoperative erythrocyte sedimentation rates. Detailed analysis was performed on the preoperative, postoperative and final follow up Xrays.

<u>Indication for Total Hip Arthroplasty</u>	<u>No. of Hips</u>	<u>Percentage</u>
1. Painful hip and limited range of motion.	15	37.5
2. Ankylosis of hip in unacceptable position with mild pain.	20	50
3. Rest pain	5	12.5
	<hr/> 40	<hr/> 100

(Table 1)

Indications of total hip arthroplasty in 40 hips in 23 patients with ankylosing spondylitis.

<u>Types of Total Hip Arthroplasty</u>	<u>No. Performed</u>	<u>Percentage</u>
Charnley low friction arthroplasty	22	55
Trapezoidal 28 arthroplasty	15	37.5
McKee Farrar arthroplasty	3	7.5
(Table 2)	<hr/> 40	<hr/> 100

Types of total hip arthroplasty performed in 40 hips in 23 patients with ankylosing spondylitis.

## RESULTS

**Pain** — Hip pain grading after arthroplasty was assessed at least one year after the operation. Thirty seven hips had improvement with pain. Three hips which had significant preoperative pain and limitation of motion had deterioration of pain during follow up. The distribution of hip pain grading is shown in Figure 1. One patient (C.K.L.) had radiological evidence of loosening of both components of his McKee Farrar hip performed thirteen years ago (Xray 1). The second patient (F.C.O.) had persistent pain over the past five years in the hip with a McKee Farrar prosthesis done eleven years ago. This is due to poor positioning and loosening of the acetabular component (Xray 2). Because of persistent pain, a revision hip arthroplasty of the Charnley type was necessary. The third patient (T.C.H.) had persistent pain for one year after operation due to deep infection. Later, conversion into Girdlestone arthroplasty was necessary and the pain was cured.

**Walking ability** — Fifteen patients (with twenty seven total hip arthroplasties) had improvement in walking ability. One patient with unilateral hip operation remained static. However, seven patients (with twelve total hip arthroplasties, including the revision arthroplasty) still required an external aid for walking after the operation. All seven patients required similar external aids for walking prior to operation. The reasons for requiring external aids for walking in these seven patients are listed in table 3.

<u>Patient</u>	<u>No. &amp; Nature of Ext. Aid</u>	<u>Reason</u>
1. L.P.K.	1 axillary crutch	Pain in unoperated hip
2. L.C.S.	2 sticks	Girdlestone operation for infected arthroplasty
3. F.C.O.	1 stick	1 Revision arthroplasty
4. A.Y.P.H.	1 axillary crutch	Painful spinal pseudarthrosis
5. T.C.H.	2 sticks	Girdlestone operation for infected arthroplasty
6. O.Y.C.	2 sticks	Severe kyphosis, Bilateral knee flexion contracture
7. L.M.C.	2 sticks	Bilateral total knee arthroplasty. Hip re-ankylosis

(Table 3)

Patient requiring external aids after total hip arthroplasty.

**Range of Motion** — Seven hips from five patients with inadequate charting of hip range preoperatively were excluded from analysis. Fifteen patients (with twenty nine total hip arthroplasties) had significant improvement in total range of movement postoperatively. Of these fifteen patients, thirteen had ankylosed hips preoperatively. Three patients (with four total hip arthroplasties) had severe limitation of range of movement postoperatively. The first patient (L.M.C.) had excessive disease activity requiring replacement of both hips and knees. He did not undergo a proper course of physiotherapy postoperatively. Reankylosis of his hips occurred shortly after the operation (Xray 3). Two other patients (L.C.S. and T.C.H.) developed progressive decrease in range of hip motion four and one year respectively after operation. Both of them were proven to have deep infection and Girdlestone excisional arthroplasty had to be performed. Subsequently their hip range improved. The distribution of total hip range of movement pre and postoperatively is shown in Figure 2.

## COMPLICATIONS

**Infection** — Four hips were complicated by infection. Two were due to deep infection by staphylococcus aureus both of which required Girdlestone arthroplasty. They subsequently healed after a prolonged course of antibiotics. Two cases developed superficial wound infection healed after secondary suturing.

**Radiological Loosening** — Radiological loosening occurred in six hips. All three McKee Farrar prosthesis were loosened in both components on follow up Xray. One McKee Farrar prosthesis was revised using Charnley low friction arthroplasty because of loosening of femoral component together with malposition of acetabular component, causing pain. The other two patients with McKee-Farrar prosthesis also became painful but one had mild pain which is relieved by rest. The other patient refused revision surgery. The other three hips showing radiological loosening all had trapezoidal 28 arthroplasties but only one had significant pain and a Girdlestone operation was performed because of deep infection by staphylococcus aureus. The average duration of follow up for these six cases having radiological evidence of loosening was 8.5 years which is longer than those without (3.5 years).

**Reankylosis** — This occurred in three patients (L.M.C., L.C.S. and T.C.H.). The latter two improved in their range after Girdlestone operation for deep infection. Only L.M.C. had reankylosis due to active disease (Erythrocyte sedimentation rate 90 mm/hr). No significant para-articular ossification is seen on final follow up (Xray 3). He also had bilateral knee arthroplasties which however gave him no useful knee range. He required two sticks for ambulation.

## ASSOCIATED PROBLEMS

**Spinal Problems** — Clinical examination showed all cases had significant ankylosis of the spine especially in the lumbar region. Five cases had spinal pseudoarthrosis (Xray 4) of which two had significant pain requiring anterior spinal fusion, three and four years after their hip operations respectively. Two cases had significant kyphotic deformity requiring spinal osteotomy at the lumbar region, again after hip surgery. All seven cases had complete ankylosis of hips.

**Disease Activity** — Thirteen patients had documented preoperative and postoperative erythrocyte sedimentation rate. The average pre-operative and post-operative erythrocyte sedimentation rates were sixty four and 41.3 respectively. Only four cases had higher erythrocyte sedimentation rate on follow up. Two of these patients had deep infection (ESR 96 and 100 mm/hr) while the third had a spinal pseudoarthrosis requiring an anterior spinal fusion (ESR 80 mm/hr). The fourth patient L.M.C. had excessive disease activity. He developed reankylosis in both hip and knee replacement shortly after operation (ESR 90 mm/hr).

## DISCUSSION

In performing total hip arthroplasty for patients with ankylosing spondylitis, it is important to have proper selection of cases. We share similar experience with Welch<sup>6</sup> and Bisla<sup>5</sup> in the belief that there is minimal indication for hip replacement due to pain alone since in most cases, this can be treated conservatively by analgesics. In our series, only 5 patients (12.5%) had total hip arthroplasty performed due to rest pain, while the remaining 87.5% had either initial ankylosis of hip or severe limitation of range of movement pre-operatively.

In analysing the result of the operation, it was noticed that total hip arthroplasty does provide significant relief of pain. 37 hips (92.5%) were pain free. Only 3 hips (7.5%) had persistent pain after the operation. Of these three hips, two had McKee Farrar prosthesis performed thirteen and eleven years before. The remaining painful hip had a Trapezoidal twenty eight replacement. In those with Charnley low friction arthroplasty, no significant post-operative pain was noted. Despite the longer duration of follow up in those patients with McKee Farrar prosthesis, our data confirmed the observation made by William et al<sup>7</sup> that this type of hip replacement does have significant association with post-operative pain.

The functional improvement in walking ability and improved total range of movement after total hip arthroplasty in ankylosing spondylitis is well shown in the results (Figure 1 and 2). This is in concordance with other reports<sup>6, 7</sup>. The major factors that hinder improvement being deep infection in the joint requiring Girdlestone operation,

symptomatic loosening of the implant requiring revision surgery, reankylosis of the replaced hip probably related to excessive disease activity, pain in contralateral unoperated hip, painful spinal pseudoarthrosis and severe spinal kyphosis. One case had bilateral knee replacement in addition to bilateral hip arthroplasty during the very active stage of the disease. With significant involvement of hips and knees, the prognosis is guarded. This patient still required two sticks for ambulation.

Xray features of implant loosening correlate poorly with symptoms except in cases of deep infection. Of all six cases of suspected mechanical loosening on follow up Xrays, only one was symptomatic enough to warrant a revision arthroplasty. Therefore in symptomatic patients with Xray evidence of loosening in either components, it is essential to rule out deep infection. A blood erythrocyte sedimentation rate will help greatly in the differential diagnosis.

Hip reankylosis had not been a significant problem in our series. It occurred only in 3 patients (7.5%). Reports on its incidence varied from 1.9 percent<sup>6</sup> to 14.3 percent<sup>2</sup>. Comparison of different series is not valid because different criteria were used by different authors. The value of careful irrigation of surgical wound with normal saline to rid of all the bone fragments together with supervised postoperative physiotherapy in helping to reduce the chance of subsequent reankylosis cannot be overstressed.

The high incidence of associated spinal problems in patients with ankylosing spondylitis requiring total hip arthroplasty is interesting. Many ankylosing spondylitis have normal daily activities. It seems in these active spondylitis, the stress in the fused spine is less shielded if there is concomitant hip ankylosis thus predisposing further to the appearance of a pseudoarthrosis. Even with successful total hip replacement, two out of five spinal pseudoarthrosis were symptomatic enough to require anterior spinal fusion. We agree that an ankylosed spine may impose excessive strain on the artificial joint causing late failure of the prosthesis<sup>5</sup>. However we must stress that an ankylosed spine with excessive kyphosis will increase even further the abnormal strain on the hip replacement. Thus for prognostication of the hip replacements in ankylosing spondylitis, concomitant spinal abnormalities in the form of pseudoarthrosis or excessive kyphotic deformity must be taken into account carefully.

Patients with ankylosing spondylitis need their operation at a younger age than those with rheumatoid arthritis or osteoarthritis. For these patients rendered immobile by stiff hips and an unyielding lumbar spine, total hip arthroplasty offers a prospect of independence during early working life.

## REFERENCE

1. Arden, G.P., *Total Hip Replacement in Juvenile Chronic Polyarthritis and ankylosing spondylitis. Orthop. Digest* 14-23 December 1974.
2. Arden, G.P. And Ansell, B.M., *Total Hip Replacement in Inflammatory Arthritis. Edited by M. Jayson, London, Sector Publishing Ltd. 1971.*
3. Dwosh, I.L., Resnick, D. & Becker, M.A., *Hip Involvement in Ankylosing Spondylitis. Arthur. and Rheum.* 19,683-692, 1976.
4. Law, M.A., *Surgical Treatment of the Rheumatic Disease. J. Bone & Joint Surgery, 34-B, 215-225, 1952.*
5. Bisla, R.S., Ranawat C.S., and Inglis A.E., *J. Bone & Joint Surgery, 58A No.2, March 1976.*
6. Welch, R.B. and Charnley, J., *Low Friction Arthroplasty of the Hip in Rheumatoid Arthritis and Ankylosing Spondylitis. Clin. Orthop.* 72, 22-32, 1970.
7. William, E., Taylor A. R. Arden G.P. and Edwards D.H., *Arthroplasty of the hip in ankylosing spondylitis. J. Bone & Joint Surgery, Vol. 59B No.4, Nov. 1977.*



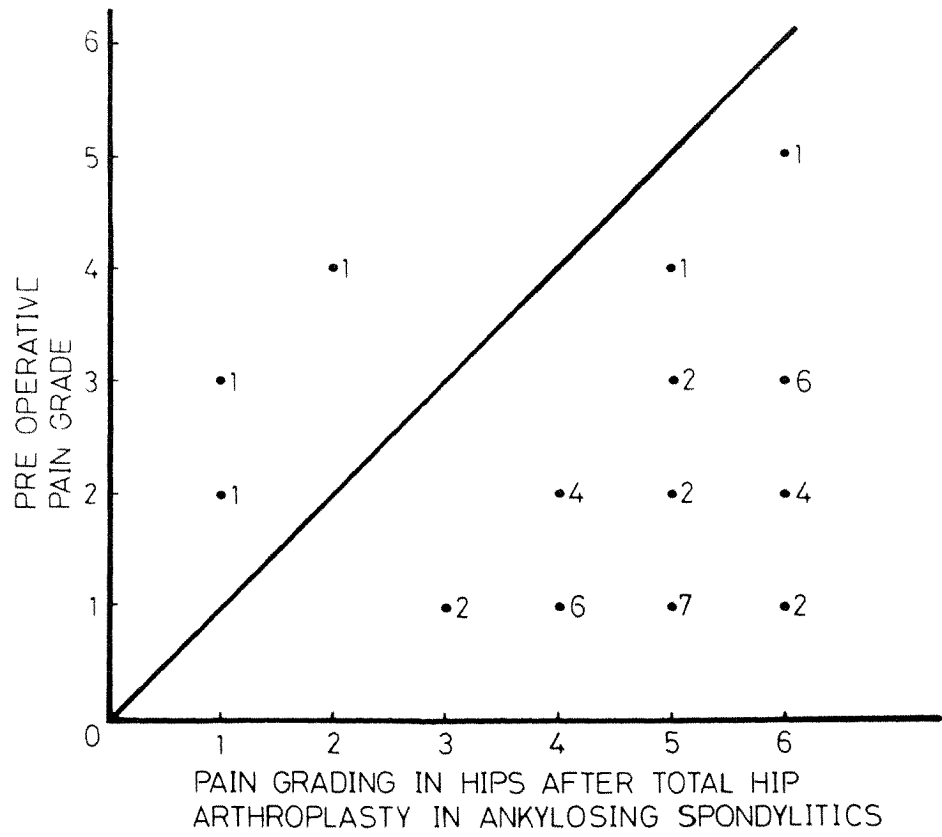

FIGURE 1

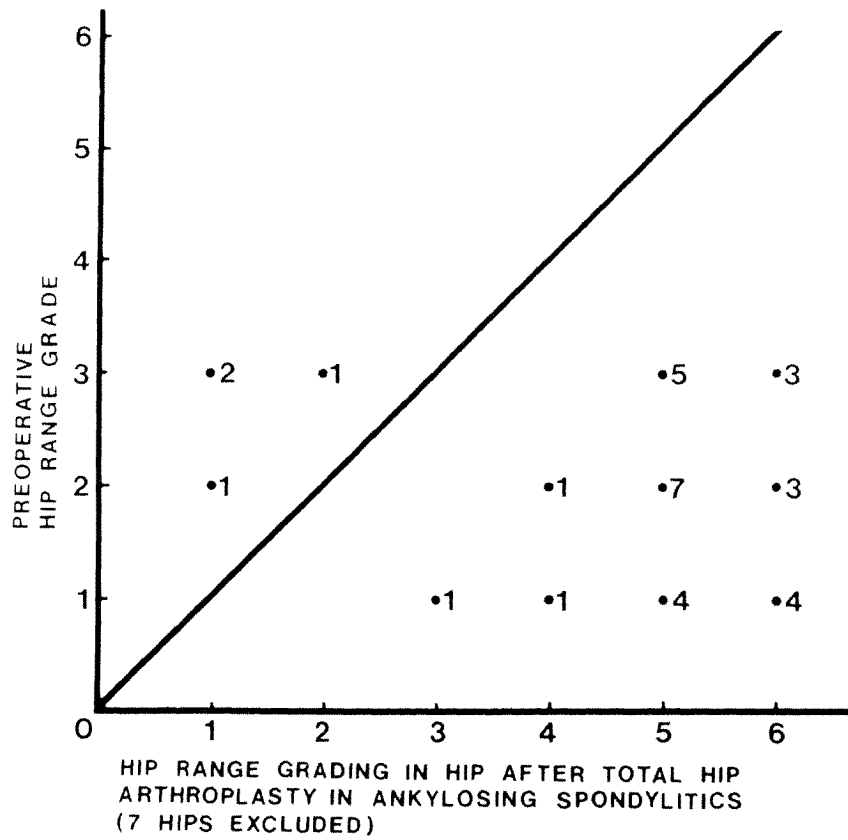
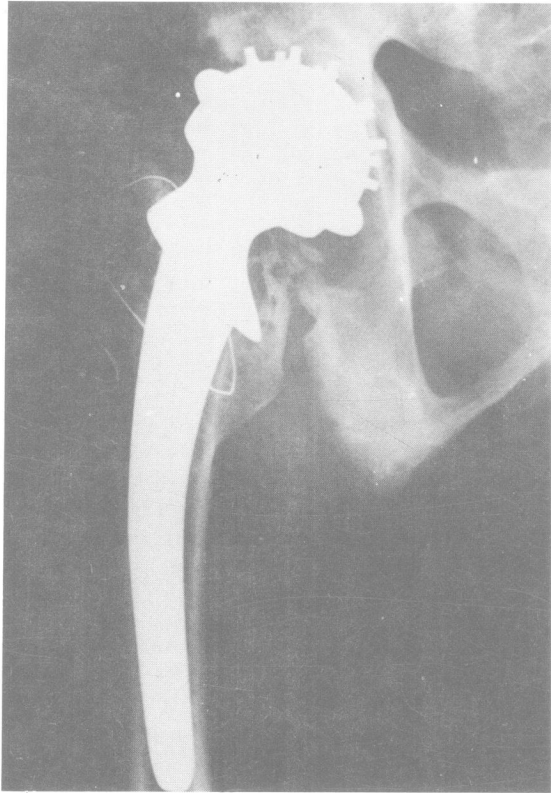
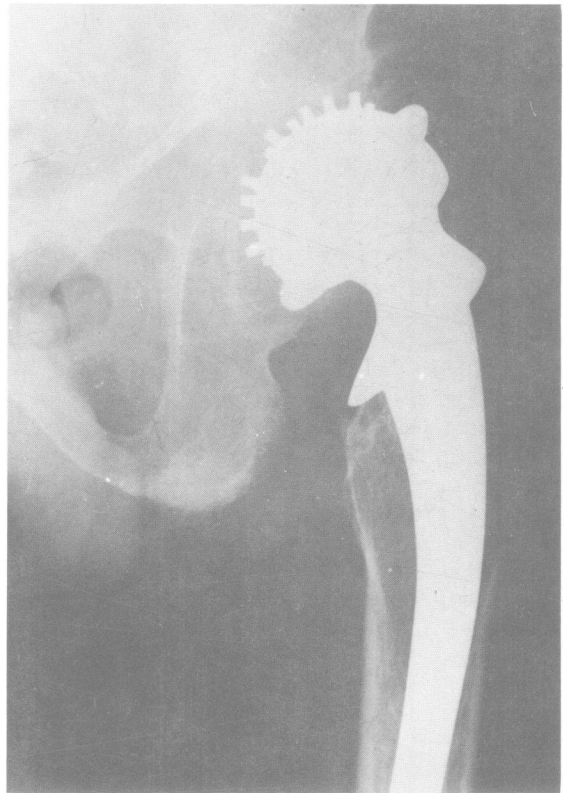

FIGURE 2



X Ray 1



X Ray 2



X Ray 3

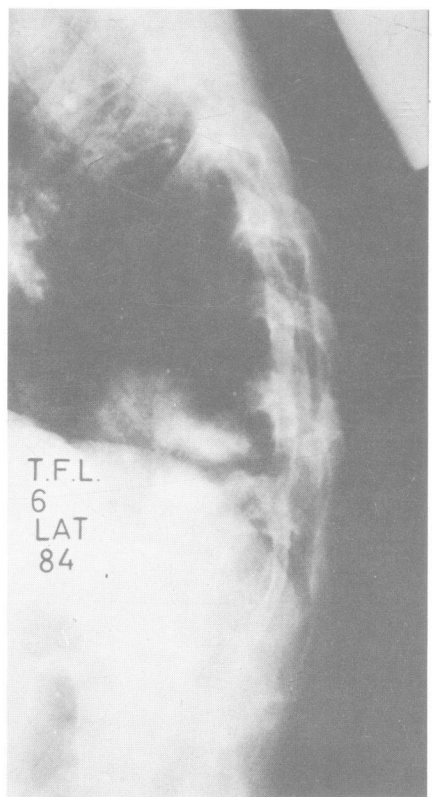

X Ray 4



# RADIOLOGICAL STUDY OF THE OSSIFICATION PATTERN IN THE SPINE AFFECTED BY ANKYLOSING SPONDYLITIS

Eric K. W. Ho\*, F. L. Chan\*\*

Louis C. S. Hsu\* , John C.Y. Leong\* and Arthur C.M.S. Yau\*

\* Department of Orthopaedic Surgery, Queen Mary Hospital, Hong Kong.

\*\*Institute of Radiology & Oncology, Queen Mary Hospital, Hong Kong.

## ABSTRACT

Spinal involvement is a cardinal feature in Ankylosing Spondylitis. In the early stage of this disease, there is formation of syndesmophytes which represent ossification of the outer fibers of the annulus fibrosus<sup>1</sup>. Subsequent progression of the ossification process produces squaring of the vertebrae thus leading to the bamboo spine at the later stage of the disease. Emphasis, however, has not been placed on the fact that in the axial skeleton, the disease affects the posterior joints of the thoracolumbar spine initially<sup>2</sup>. The significance this disease pattern has on the extent of spinal osteotomy performed for treatment of deformity caused by Ankylosing Spondylitis was also not widely recognized. This review represents a cross-sectional study of 108 cases of Ankylosing Spondylitis with definite spinal changes radiologically. The intervertebral disc, anterior longitudinal ligament and posterior longitudinal ligament constitute the anterior compartment which can have extensive ossification at the late stage of the disease. The ligamentum flavum and posterior apophyseal joints are considered as the posterior compartment. From the analysis of these 108 cases, it can be concluded that posterior compartment disease starts earlier and progresses faster than the anterior disease. The surgical significance of this observation was well illustrated by a patient who was treated with posterior wedge osteotomy for his kyphotic deformity.

## INTRODUCTION

Spinal involvement is a cardinal feature in Ankylosing Spondylitis. In the early stage, there is radiological evidence of the presence of syndesmophytes, which are ossification of the outer fibres of the annulus fibrosus<sup>1</sup>. Subsequent progression of the ossification produces squaring of the vertebrae thus leading to the bamboo spine appearance at the later stage. The disease also affects the posterior joints of the axial skeleton, particularly at the thoracolumbar region<sup>2</sup>. The affection of these posterior joints probably starts earlier than the anterior disease. This study attempts to clarify the ossification pattern affecting the anterior and posterior compartment of the spine. The surgical implication of studying the disease pattern was illustrated by reporting a case of spinal osteotomy performed in a patient with kyphotic deformity.

## MATERIAL AND METHOD

One hundred and forty two cases of Ankylosing Spondylitis were seen at the Duchess of Kent Children's Hospital, Hong Kong, from January, 1981 to June, 1983. All of them had their blood tested for the presence of HLA B27 Antigen which was found to be uniformly positive.

The spinal X-rays of these 142 patients were analyzed. Special attention was paid to the presence of syndesmophytes and calcification of the anterior and posterior longitudinal ligament as well as that of the apophyseal joint. The disease process was studied by arbitrarily dividing the axial skeleton into the anterior and posterior compartments. The anterior compartment consists of the disc, the anterior longitudinal ligament and the posterior longitudinal ligament. The posterior compartment is made up of the apophyseal joints and the ligamentum flavum.

The early stage of the disease was studied by comparing the presence of syndesmophytes anteriorly and ligamentous ossification posteriorly. For patients with late disease, the difference in ligamentous ossification in the anterior and posterior compartments was compared. Correlation between the ossification pattern and clinical deformity was also analyzed.

## RESULTS

Of the 142 cases studied, only 108 patients had definite X-ray changes. Radiological evidence of syndesmophytes were observed in 78 patients (72%). Among these 78 patients, about 50% showed extensive involvement.

A comparison was made between the anterior compartment syndesmophytes and the posterior ossification. It was noted that all patients with syndesmophytes had simultaneous posterior ossification, whereas 15 patients with very extensive posterior ossification did not possess any syndesmophytes anteriorly.

At a later stage of the disease, the anterior compartment ossification was compared with that of the posterior compartment. The posterior compartment ossification was much more severe than its anterior equivalent in 42 cases (50%). On the contrary, only three cases had more extensive anterior ossification than that occurring posteriorly.

Correlation of clinical kyphotic deformity with the radiological pattern of ossification showed, that in most patients, significant kyphosis was associated with combined anterior and posterior disease. However, in three patients with severe kyphotic deformity, there was posterior compartment ossification only.

## DISCUSSION

Spinal ossification can be used arbitrarily as a measure of the severity of the disease. The ossification pattern can be studied radiologically. The division of the ossification into the anterior and posterior compartments facilitates the study of the disease pattern as well as the disease progress.

Syndesmophyte has been claimed to be one of the earliest radiological signs of spinal disease, preceded only by the presence of erosions at the site of attachment of the annulus fibrosus. (3). In this study, however, it is revealed that the appearance of syndesmophytes can be preceded by extensive posterior compartment disease, as fifteen patients had posterior ossification without radiological evidence of syndesmophytes. Moreover, all cases with syndesmophytes had posterior element disease. This clearly indicates that the disease starts earlier in the posterior compartment than in the anterior compartment.

The degree of ossification of the posterior compartment is often underestimated on the X-rays mainly because of the overlapping of the posterior element of the spine. Despite this possible underestimation, in this series of 108 cases, about 50% of them had more marked ossification posteriorly. This indicates that in the posterior compartment ossification progressed faster than its anterior equivalent.

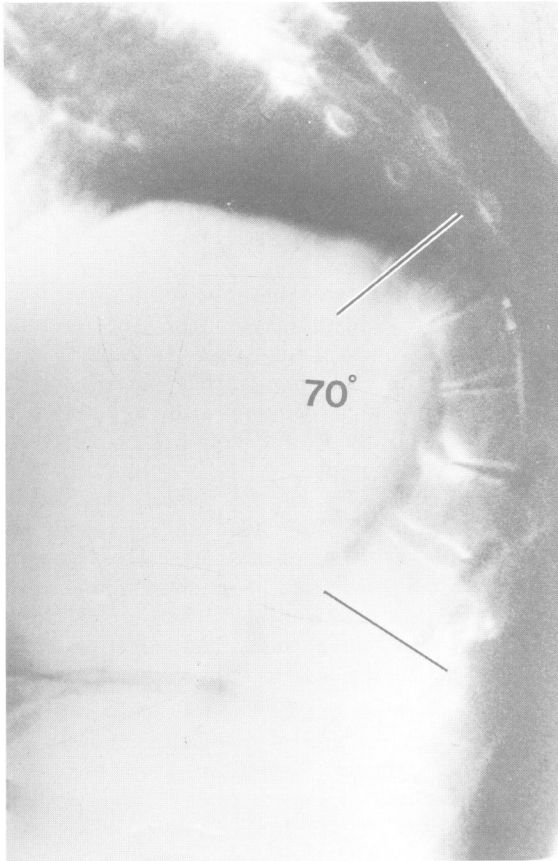

Figure 1 X-ray spine of Mr. A before operation

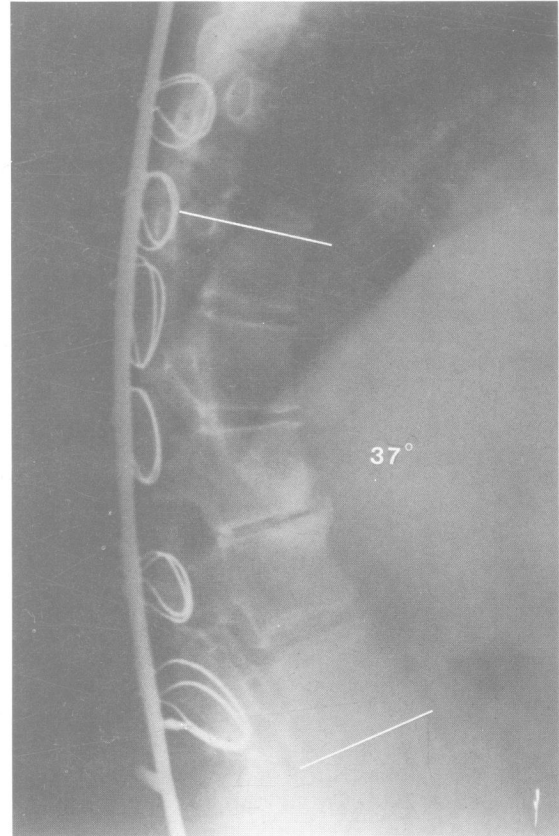

Figure 2 X-ray spine of Mr. A after posterior wedge osteotomy

This pattern of ossification has significant surgical implication when performing spinal osteotomy for correction of kyphotic deformity of the spine affected by Ankylosing Spondylitis. In selected cases with ossification of the posterior compartment only, as illustrated by three of our patients, surgical correction would involve osteotomizing the posterior compartment alone, thus leaving the anterior compartment undisturbed. This would reduce the extent of the surgery. The operative morbidity and mortality will be similarly minimized.

The advantage of prior knowledge of the ossification pattern in influencing operative management can be well illustrated by the following case. Mr. A was a 35 year old gentleman with Ankylosing Spondylitis who had significant kyphotic deformity over the thoracolumbar region. Radiological examination of the spine revealed a Kyphosis of 70 degrees. (Figure 1). It was noticed that while there was extensive ossification in the posterior compartment, the anterior compartment was uninvolved. A posterior wedge osteotomy corrected the deformity without any difficulty. The Luque instrumentation was used to stabilize the spine after the osteotomy. Postoperative radiological examination revealed that the kyphosis had been reduced to 37 degrees. (Figure II). There was also good correction of the kyphotic deformity clinically.

## CONCLUSION

From this brief review, it is concluded that

1. Spinal radiological changes occur earlier in the posterior compartment.
2. Posterior compartment disease progresses faster than disease in the anterior compartment, the reason being that extensive ossification was observed more frequently in the posterior compartment compared to its anterior equivalent.
3. Radiological observation of the disease pattern may influence the extent of spinal osteotomy performed for correction of kyphotic deformity of the spine affected by Ankylosing Spondylitis.

## REFERENCES

1. Ball J. (1980). 'Pathology and Pathogenesis of Ankylosing Spondylitis' *Ankylosing Spondylitis*, edited by J.M.H. Moll, 96-112.
2. Murray (1973). 'Radiology of Skeletal Disorders', edited by Churchill Livingstone, 664-667.
3. Percy J.S. and Lentle B. (1980). 'Radiological and Scintigraphic features of Ankylosing Spondylitis'. *Ankylosing Spondylitis*, edited by J.M.H Moll, 76-86.



SPINAL PSEUDARTHROSIS IN ANKYLOSING SPONDYLITIS

Fu-luk CHAN<sup>\*</sup>, Eric King-wah HO<sup>+</sup>, Louis Che-shek HSU<sup>+</sup>,  
David FANG<sup>+</sup> and John Chi-yan LEONG<sup>+</sup>

<sup>\*</sup>Institute of Radiology & Oncology, and  
<sup>+</sup>University Orthopaedic Unit, Queen Mary Hospital,  
Hong Kong.

*Address of main author*  
**Dr. F. L. Chan,**  
Department of Radiodiagnosis,  
Queen Mary Hospital,  
Pokfulam Road,  
Hong Kong.



## SUMMARY

In patients with ankylosing spondylitis, spinal pseudarthrosis is an important mechanical complication that should be separated from other minor 'destructive vertebral lesions'. It occurred in patients with over ten years of clinical disease. 34 patients with a total of 41 lesions were studied. 3 lesions occurred through vertebral bodies subsequent to complete fractures. The rest occurred at interspaces and were more common at T11/12, T12/L1 segments. 7 patients had double pseudarthroses. Progressive osteolysis of the anterior element was a prominent feature, associated with variable sclerosis, osteophytes, vacuum phenomenon, subluxation and fragmentation. A posterior element weak link, as a bony break or facet joint non-fusion, was an essential component present in every case. Its pathogenetic implication is discussed. Mechanical derangement arising from trauma, severe round kyphosis, spondylodiscitis, hip ankylosis, spinal operation and unusual activities may be contributing factors. Initial treatment is conservative, but 15 patients required operative stabilisation of the pseudarthroses.

**KEY-WORDS:** spine, ankylosing spondylitis, pseudarthrosis, stress fracture.

## INTRODUCTION

Destructive lesions of the intervertebral disc and adjoining vertebral bodies complicating ankylosing spondylitis had been reported as early as 1937. Since then various reports on such destructive spinal lesions appeared in the literature. There was, however, a confusion of terminology. 'Romanus lesions', 'Andersson lesions', 'Spondylodiscitis', 'Pseudarthrosis', 'Destructive spondylitic changes', 'Erosive vertebral disease' were some of the terms that had been employed to label various spinal destructive lesions with overlapping or interchangeable interpretation. There was also some dispute in the pathogenesis of such lesions.

Among the different forms of destructive spinal lesions in ankylosing spondylitis, spinal pseudarthrosis is the most important complication. It often causes severe back pain, and may generate neurologic sequelae from fibrous or osseous overgrowths. In the literature, most reports contained only single or several cases of spinal pseudarthrosis. The present communication aims at studying a larger group of patients with this complication, looking at its radiographic features, its association with other skeletal affection in ankylosing spondylitis, and the clinico-radiologic evidence for its pathogenesis.

## MATERIAL AND METHODS

160 patients with clinical and radiographic diagnosis of ankylosing spondylitis, attending the Spine Clinic of the University Department of Orthopaedic Surgery, were studied. This population of patients was a heterogeneous group with manifestations of various stages and severity of the disease. Among them, 18 patients with spinal pseudarthrosis were identified; bacterial spondylitis being excluded clinically. 16 additional cases with same diagnosis were available from the files of the past fifteen years of the Radiology and the Orthopaedics Departments of Queen Mary Hospital.

In this study, the term 'spinal pseudarthrosis' denotes a progressive disco-vertebral osteolytic process associated with a demonstrable weak link in the posterior elements of the corresponding segment. The anterior and posterior components together complete the 'false-articulation' in the rigid spine.

Self-limiting eburnation of disc and adjacent vertebral end-plates, without any associated posterior elements defects, were excluded. The term 'spondylodiscitis' will be confined to such self-limiting minor process usually affecting multiple levels simultaneously and occurring at an earlier stage of the disease.

The clinical data and serial radiographic studies of these 34 cases were reviewed in detail, with regard to the role of trauma, severity of the ankylosing spondylitis, condition of the hips, spinal curvature, pattern of ligamentous ossification, evidence of active or healed spondylodiscitis, plus the appearance and progress of the pseudarthrosis. Plain radiographs were available in all cases. Conventional tomography had been performed in two-thirds of the patients, and computed tomography (CT) in a few.

## RESULTS

### Incidence

Table 1 shows the sex incidence and age of presentation of our patients with pseudarthrosis. The youngest patient was a 24 years old male, while the eldest was a 60 years old female. All patients had symptoms related to ankylosing spondylitis for ten or more years, but presenting with localised back pain over the affected segment, aggravated by physical activity, when they developed pseudarthrosis.

### Level of Pseudarthrosis

There were altogether 41 pseudarthrosis lesions among the 34 patients. Three of these lesions were through the vertebral bodies, 2 at T12 and 1 at L3. The others were situated at the disc space with osteolysis of adjoining vertebral bodies. The distribution of the disc space levels affected is shown in Table 2. The thoracolumbar junctional segments between T11 and L1 accounted for 18 lesions (18/41 or 43.9%).

7 Patients had double pseudarthrotic lesions. In 4 patients the double lesions were synchronous, appearing together at the time of presentation. Among them, two had pseudarthrosis at contiguous segments,

while two had the lesions separated by a few segments. In another two patients, a second pseudarthrosis occurred at a lower level a few years after anterior spinal fusion was performed for the first pseudarthrosis (Fig. 1). One patient had healing of a spinal pseudarthrosis under conservative management, but developed a second lesion at a lower level a few years later (Fig. 2). There was no instance of more than two simultaneous lesions in a single patient.

### Anterior Element Osteolysis

In the majority of patients, there was prominent osteolytic process affecting the anterior spinal elements on presentation. The lesion consisted of osteolysis of various degrees (slight to mild n=22; moderate n=12; severe n=4) (Fig. 3) on both sides of a transverse segmental break, which was most often at a disc space, with irregular disappearance of the vertebral end-plates and adjacent vertebral bodies, sometimes resulting in ill-defined bone contours. The features were better demonstrated on tomograms. The osteolysis usually extended over the whole surface of the vertebral end-plate, but was occasionally localised. Osteolysis was often roughly equal on the two sides of the break; but more severe involvement of either the upper or lower vertebral component was also observed. Reactive sclerosis to various extent was present in the remaining portion of the involved vertebral bodies. The affected disc space was commonly widened (n=21), but might be narrowed (n=9) or normal in height (n=8). Significant anterior or posterior slip of one vertebral body on the other, on flexion/extension radiographs, was observed in 4 cases. Vacuum phenomenon was observed in 5 lesions. Severe osteolysis resulted in decreased height of the affected vertebral bodies, and angular kyphosis at the affected segment. Marginal osteophytes around the break were present in many patients, and some posterior osteophytes were seen to encroach upon the spinal canal. Fragmentation with possible sequestra were observed in one case. Localized paravertebral soft tissue swelling was found in 7 cases, among which 3 were unilateral, and all were only slight or mild.

The anterior element osteolysis was observed to progress at various rates over several years. For cases that presented early, gradual deterioration of the osteolysis was evident (Fig. 4).

In the four patients with synchronous double spinal pseudarthroses, the osteolysis was mild at the affected levels for each patient.

For the 3 lesions with segmental break across the vertebral bodies, the osteolysis was quite similar to what was just described around breaks at the disc space for other patients. It was again associated with variable adjacent sclerosis. Vacuum phenomenon and osteophytes had also been observed. The appearance could resemble that of non-united spinal fractures in a non-ankylosed spine (Fig. 5).

### Posterior Element Weakness

In 6 patients with 8 lesions, non-fused facet joints in an ankylosed spine were found at a single level or for a few contiguous levels over the segments with pseudarthrosis. The anterior element osteolysis occurred at the same level with the non-fused single level, or with the lowest non-fused level when a few levels were so affected (Fig 6).

In the other 28 patients a break was present across the ankylosed posterior elements with fused facet joints. The break varied from hair-line to several millimeters wide, and appeared as a transverse defect with reactive sclerosis, sometimes associated with marginal osteophytes. Hypertrophic changes or fragmentation of the bones bordering the defect were observed, especially on CT, in a few cases. The defect traversed the ankylosed posterior elements without predilection or respect for any specific anatomic structure. 23 of these posterior element defects were in line with, while 8 were slightly above and 2 slightly below, the anterior element osteolysis. The alignment of posterior defects was commonly horizontal (n = 20), but might be slanting up (n = 7) or down (n = 6) posteriorly. They could be detected on plain radiographs, but were often better delineated on tomograms. On the lateral projection, defects running in the direction of the usual apophyseal joints might be confused with non-fused joints, but the antero-posterior radiographs were often helpful towards such differentiation. Less severe defects sometimes could only be observed on tomograms or CT. Presence of posterior element defects alone before the development of anterior element osteolysis had been observed in patients presenting early (Fig. 7).

### Preceding Trauma/Operation

Two of the 3 patients with pseudarthrosis through the vertebral bodies had radiographs showing acute post-traumatic transverse fractures, which on serial films proceeded to non-union or fibrous union. The remaining one presented with established pseudarthrosis, and could not be related to any single injury.

Among the patients with pseudarthrosis at the disc level, one presented with acute fracture across the ankylosed posterior element, followed by progressive osteolysis in the anterior element over months (Fig. 8). 3 had healed compression fractures at segments away from the pseudarthrosis, and 5 believed that the onset of localised pain clearly dated from traumatic incidents. The history of the rest was too vague to attach significance to any particular incident of injury.

5 patients were discovered to develop spinal pseudarthrosis a few months to years after spinal operations at levels away from the eventual lesion: 2 had anterior spinal fusion for spinal pseudarthrosis at

higher levels; 1 had anterior spinal fusion for other reasons; 2 had spinal osteotomy for correction of spinal curvature.

### Spinal Curvature

5 patients had a more or less straight spine. The others had round thoraco-lumbar kyphosis of various degrees, with the apex of kyphosis either above or at the level of the pseudarthrosis.

Compared with the non-pseudarthrotic group, there was no significant difference in the incidence of associated scoliosis.

### Ligamentous Ossification

25 cases had marked ossification of the inter-spinal ligaments and joint capsules disproportional to the degree of ligamentous ossification around the vertebral bodies. This pattern of prominent ligamentous ossification of posterior elements, however, was also quite general in the non-pseudarthrotic group. There was no relation of the severity of the pseudarthrosis to the pattern of ligamentous ossification.

### Associated Spondylodiscitis

3 patients had spondylodiscitis, with serial radiographs documenting subsequent healing and fusion of the vertebrae across the involved spaces. Several years later, pseudarthroses appeared at levels previously unaffected by the spondylodiscitis (Fig 9). 5 more patients, on presenting with the pseudarthrosis, were found to have multiple, often contiguous, levels of narrowed and fused disc spaces, which might be indicative of healed spondylodiscitis.

### Hip Condition

29 patients had bilateral hip disease as a manifestation of the ankylosing spondylitis. The severity of hip disease varied from joint narrowing with erosion to completely ankylosed hips. Five patients required prosthetic hip replacements.

A survey of hip disease in the population of ankylosing spondylitics revealed that its incidence in the non-pseudarthrotic group of the Spine Clinic was 50/142 or 35.2%, while that in the pseudarthrotic group was 29/34 or 85.3%. Nevertheless, these two groups were not strictly comparable in view of non-uniformity as regards duration and severity of disease.

### Results of Treatment

Patients with spinal pseudarthrosis were initially advised of immobilisation, given symptomatic treatment and spinal support. 6 patients defaulted follow-up so that their response could not be assessed. 3 patients had spontaneous healing and fusion across the affected segment on conservative management.

15 lesions had progressive osteolysis or remained painful despite conservative treatment. They

eventually underwent anterior spinal fusion. The pseudarthrosis was resected and the related vertebral bodies fused. 9 of them demonstrated good post-operative bony union. 4 operated lesions showed partial fusion with relief of local back pain. Non-union occurred in 2 operated lesions, one of which received subsequent posterior spinal fusion with good result.

### DISCUSSION

According to various reports in the literature, O. Andersson was the first to describe in 1937 disc-vertebral destructive lesions occurring in ankylosing spondylitis. In a study of 114 men with ankylosing spondylitis Romanus stated that various degrees of destructive lesions were found in practically all cases with spinal changes (Romanus & Yden, 1952). He gave a detailed demonstration of the classical 'Romanus Lesion', or anterior spondylitis, which might be the precursor and pre-requisite of syndesmophyte. He also described spondylodiscitis, speculating it as an advanced extension of anterior spondylitis. The prevalence of destructive lesions reported in different series, however, varied between 1% and 28% (Cawley et al., 1972), being influenced by the spectrum of patients and the lack of agreed diagnostic criteria.

There is a lack of uniformity in the terminology applied to such 'destructive lesions'. The term 'spondylodiscitis' had been employed to describe various specific types of destruction, as well as sometimes to embody all types of destruction (Simmons & Goodwin, 1983). The same comment also applies to non-committal descriptive terms like 'destructive vertebral lesions' (Frank & Gleason, 1975) or 'erosive vertebral disease' (Hicklin, 1968). Pathogenetically neutral nomenclature after names had been suggested, but was at times confusing. The term 'Romanus lesion', for example, had been used to denote different types of destruction (Murray & Jacobson, 1977). Attempts to classify them into localized/extensive lesions (Cawley et al., 1972) or inflammatory/non-inflammatory types (Dihlmann & Delling, 1978) were useful concepts, although there might be reservations about their prognostic or pathogenetic implications. Forestier & Faidherbe, 1949, reported the first case of 'spinal pseudarthrosis' in ankylosing spondylitis. This term had since often been used for the progressive destructive lesion in ankylosing spondylitis (Martel, 1978; Pastorschank & Resnick, 1980). The term stresses the mechanical derangement, and implies a condition that demands treatment aimed at stabilising the mechanical defect. Park et al., 1981, reported 16 cases of pseudarthrosis studied by scintigraphy, when he assessed the incidence of pseudarthrosis to be 2.5%. The much higher incidence among our patients may be related to the large proportion of long-established disease and the referral of symptomatic cases in the territory to the Spine Clinic of our hospital. It should not be

interpreted as revealing the true statistics of the population.

The traumatic or mechanical hypothesis of pathogenesis of 'destructive lesions' is overwhelmingly favoured by modern authors, instead of a primarily infective or inflammatory origin as previously believed (Forestier & Faidherbe, 1949). The relation to trauma (Hunter & Dubo, 1983) and heavy manual occupation (Cawley et al., 1972) has been noted. Histology of excised tissue within destructive lesions has been compatible with pseudarthrosis. The clinical presentation of our patients is also in line with similar pathogenesis. A few had acute fractures either completely across the ankylosed spine, or only over the posterior elements, then proceeding to typical pseudarthrosis. Conditions which predispose to exaggerated gravitational stress on the spine, for example, severe road thoracic kyphosis and hip ankylosis, are more common in pseudarthrotic patients. It is also likely that patients with severe round kyphosis and hip ankylosis are more restricted in mobility, with higher chance of repeated stress trauma to their spines. The most frequent site of pseudarthrosis being at the thoraco-lumbar junctional region (T11 – L1) also lends support to the mechanical theory of pathogenesis, since these are the segments with disc spaces most susceptible to shearing or distraction under the effect of gravity in a kyphotic spine. The actual site of maximal stress, of course, does shift depending on the disordered structural mechanics of the individual spine, as modified by the spinal curvature, distribution and rate of progress of ankylosis, hip mobility, body-build and patient's activity. Situations which may disrupt a presumably stable disordered mechanics in an ankylosed spine, with alteration of the mechanical alignment, may subscribe towards the formation of a pseudarthrosis. Spinal operations (anterior spinal fusion or spinal osteotomy), healed spondylodiscitis, compression fractures or healed pseudarthrosis at one segment had been associated with the development of pseudarthrosis at another segment in our series.

We reckon that a posterior element weakness is the essential component with initiating significance. All our patients had a demonstrable weak link in the posterior elements of the affected segment of the spine. The weakness may be bony defects or unankylosed facet joints. Early lesion is difficult to diagnose in view of surrounding osseous proliferation, and may require tomogram or CT to diagnose or distinguish. Yau & Chan, 1974, reported posterior bony defects that might not be widely separated, and documented features suggesting stress fractures. Cawley reported fractures through the neural arches in 2 of his 5 cases of extensive destruction, while Dihlmann noticed 2 such fractures among his 8 'non-inflammatory type' destructive lesions. In the reports of Kanefield et al., 1969, and Dihlmann & Delling, 1978, there were examples of traumatic fractures of posterior elements followed by severe disco-vertebral destruction after months to years. We had

one similar instance. Pastershank & Resnick, 1980, documented with radiographs of cadaver specimens fractures through the intervertebral disc extending into the neural arch; but such 'fractures' through the discs may be difficult or impossible to demonstrate in the living persons, although vacuum phenomenon was noted in 4 of our cases. Furthermore, we notice that pseudarthrosis developing from non-union or fibrous union of transverse vertebral body fractures of ankylosed thoracolumbar spine had appearance similar to pseudarthrotic lesions at disco-vertebral sites. On the other hand, Rivelis & Freiburger, 1969, described pseudarthrosis in the unankylosed portion of ankylosing spondylitis, under the abnormal stresses imposed on an isolated mobile segment of a rigid spine. 8 lesions in our series had non-fused facet joints over portion of the spine corresponding to pseudarthrotic sites.

We believe that pseudarthrosis can develop from either of the following two mechanisms:

- (a) Non-union or fibrous union of complete transverse fracture, the anterior component passing through either the disc or vertebral body.
- (b) The disc becoming vulnerable to abnormal stress from concentration of movements of entire spine on a segment with a posterior element weakness, which may be non-fused facet joints, or a bony defect, be it fracture or stress fracture.

In either situation, the continuous mechanical strain and abnormal motion lead to progressive resorption of the disc and the adjoining vertebral bodies, and continuing repair reaction by connective tissue.

We propose to segregate pseudarthrosis completely from the various other minor and self-restricting forms of 'destructive vertebral lesions' in ankylosing spondylitis. Spinal pseudarthrosis stands out radiologically as a condition with anterior element disco-vertebral osteolysis in the presence of a posterior element weak link; and clinically as a lesion of management significance, with respect to persistent painful symptoms, likelihood of progressive myelopathy (Good et al., 1982) and surgical implications. It occurs almost exclusively in spines with advanced ankylosis. Affected patients are initially treated conservatively. This is sufficient in some patients, with relief of symptoms, and radiographic evidence of non-progression of the destruction or occasionally bony union. Patients not responding to conservative treatment warrant surgical intervention with the aim of fusing the painful unstable segment. The anterior approach is often recommended, both for direct vision of the disease and to achieve sound union. In our series, such intervention had resulted in 9 bony union and 4 symptom-free partial union in 15 operated lesions. However, it must be viewed against the occurrence of non-union in 2 lesions, and the development of a second pseudarthrosis at another segment after

the spinal fusion in 2 cases. Posterior spinal fusion induced healing in one of our non-united lesion after the anterior approach, presumably a result of

removing the posterior instability, thus breaking the vicious cycle to alleviate the progressive osteolysis at the anterior elements.

## REFERENCES

- Cawley, M.I.D., Chalmers, T.M., Kellgren, J.H. & Ball, J. (1972). Destructive lesions of vertebral bodies in ankylosing spondylitis. *Annals of Rheumatic Disease*, 31, 345-358.
- Dihlmann, W. & Delling, G. (1978). Disco-vertebral destructive lesions (so-called Andersson lesions) associated with ankylosing spondylitis. *Skeletal Radiology*, 3, 10-16.
- Forestier, J. & Faidherbe, P. (1949). Spondylite et spondylarthrite. *Journal of Radiol. Electrol. Med. Nucl.*, 30, 569-570.
- Frank, P. & Gleeson, J.A. (1975). Destructive vertebral lesions in ankylosing spondylitis. *British Journal of Radiology*, 48, 755-758.
- Good, A.E., Keller, T.S., Weatherbee, L. & Braunstein, E.M. (1982). Spinal cord block with a destructive lesion of the dorsal spine in ankylosing spondylitis. *Arthritis and Rheumatism*, 25, 218-222.
- Hicklin, J.A. (1968). Erosive vertebral disease in ankylosing spondylitis. *Annals of Physical Medicine*, 9, 206-209.
- Hunter, T. & Dubo, H.I.C. (1983). Spinal fractures complicating ankylosing spondylitis. *Arthritis and Rheumatism*, 26, 751-759.
- Kanefield, D.G., Mullins, B.P., Freehafer, A.A., Furey, J.G., Horenstein, S. & Chamberlin, W.B. (1969). Destructive lesions of the spine in rheumatoid ankylosing spondylitis. *Journal of Bone and Joint Surgery*, 51-A, 1369-1375.
- Martel, W. (1978). Spinal pseudarthrosis – a complication of ankylosing spondylitis. *Arthritis and Rheumatism*, 21, 485-490.
- Murray, R.O. & Jacobson, H.G. (1977). *The Radiology of Skeletal Disorders*. P.P. 842 Churchill Livingstone. Edinburgh London.
- Park, W.M., Spencer, D.G., McCall I.W., Ward, D.J., Buchanan, W.W. & Stephens, W.H. (1981). The detection of spinal pseudarthrosis in ankylosing spondylitis. *British Journal of Radiology*, 54, 467-472.
- Pastershank, S.P. & Resnick, D. (1980). Pseudarthrosis in ankylosing spondylitis. *Journal of the Canadian Association of Radiologists*, 31, 234-235.
- Rivels, M. & Friberger, R.H. (1969). Vertebral destruction at unfused segments in late ankylosing spondylitis. *Radiology*, 93, 251-256.
- Romanus, R. & Yden, S. (1952). Destructive and ossifying spondylitic changes in rheumatoid ankylosing spondylitis. *Acta Orthopedics Scandinavia*, 22, 88-99.
- Simmons, E.H. & Goodwin, C.B. (1983). Spondylodiscitis: a manifestation of ankylosing spondylitis. *18th Annual Meeting of the Scoliosis Research Society Meeting, Paper No. 63.*
- Yau, A.C.M.C. & Chan, R.N.W. (1974). Stress fracture of the fused lumbo-dorsal spine in ankylosing spondylitis. *Journal of Bone and Joint Surgery*, 56-B, 681-687.

**Table 2 – Level Distribution of Pseudarthrosis through Disc**

Spinal Segment	Number of lesions
T 9–10	2
T10–11	3
T11–12	6
T12–L1	10
L 1–2	4
L2–3	7
L3–4	2
L4–5	4
<b>Total</b>	<b>38</b>

**Table 1 – Sex and Age Distribution**

Age of presentation (range in years)	Number of patients	
	Male	Female
21 – 30	7	0
31 – 40	10	1
41 – 50	11	1
51 – 60	2	1
61 – 70	0	1
<b>Total</b>	<b>30</b>	<b>4</b>

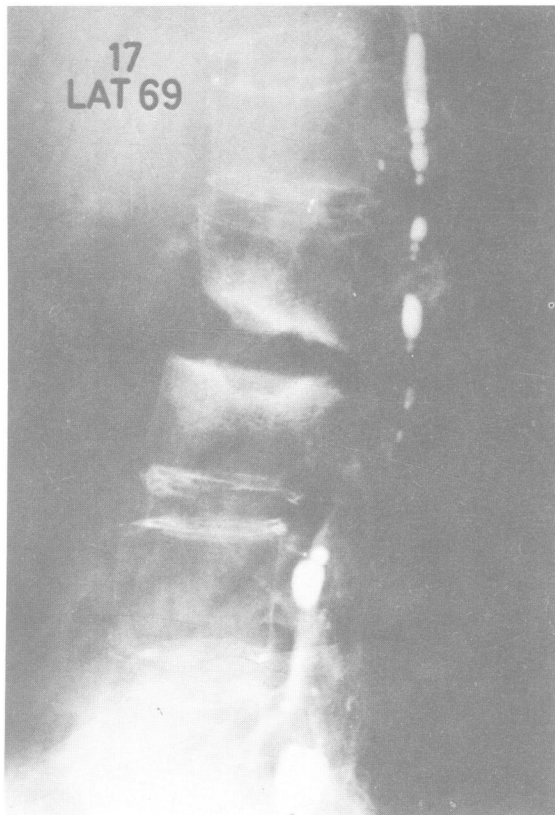

Figure 1A

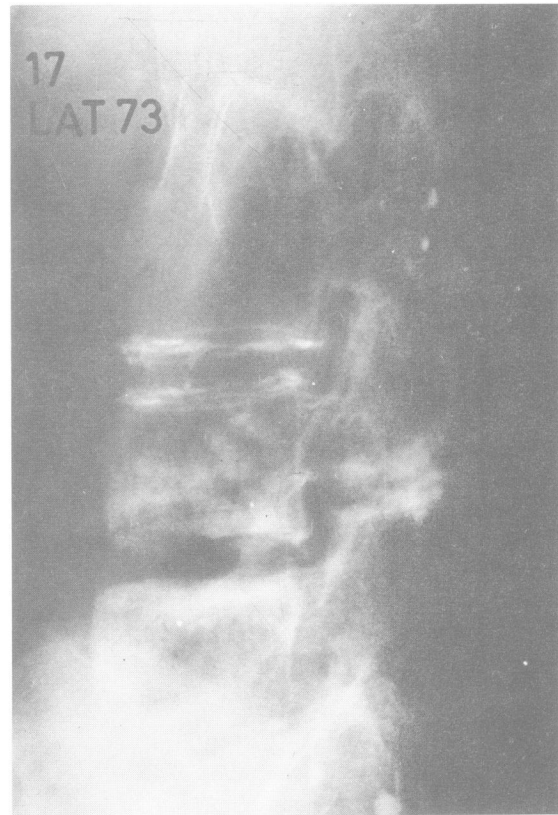

Figure 1B



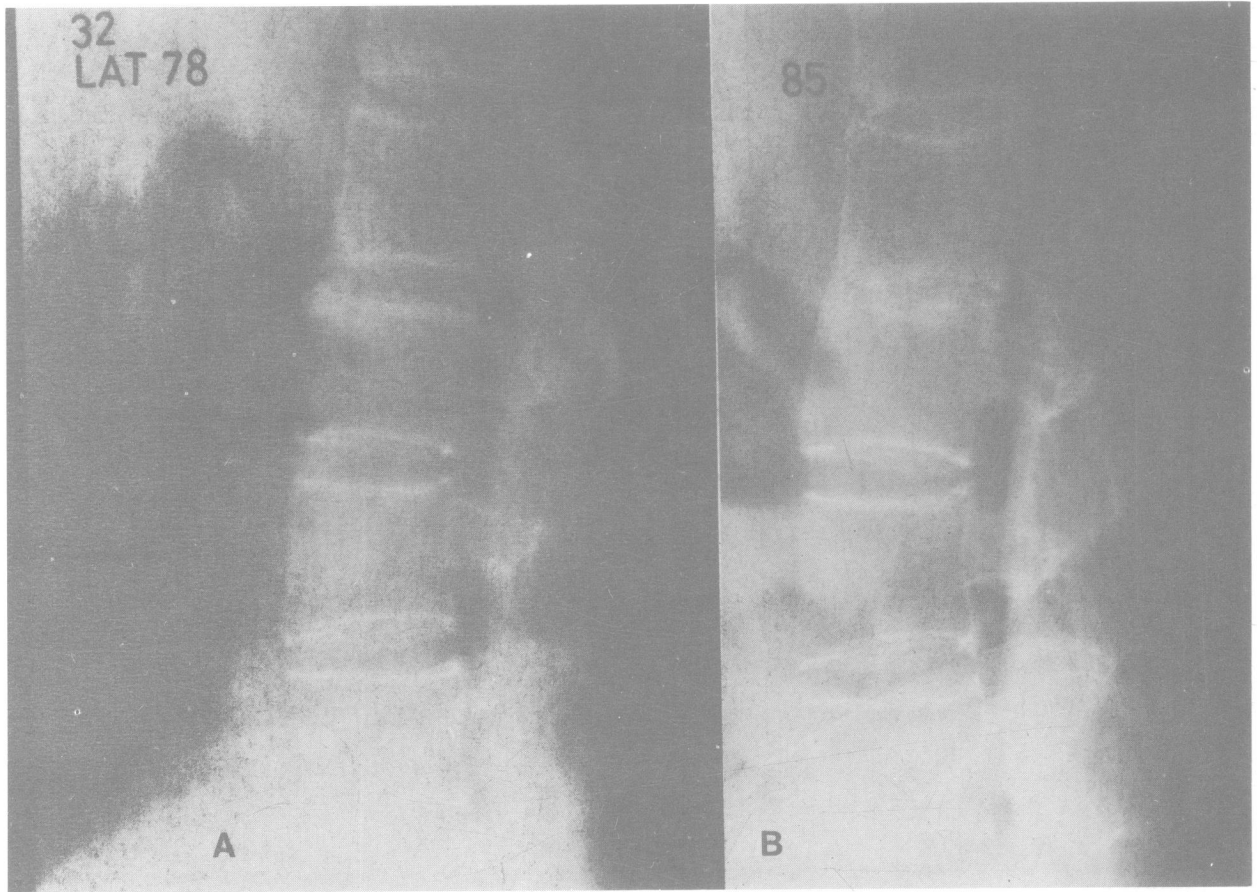

Figure 2



Figure 3A

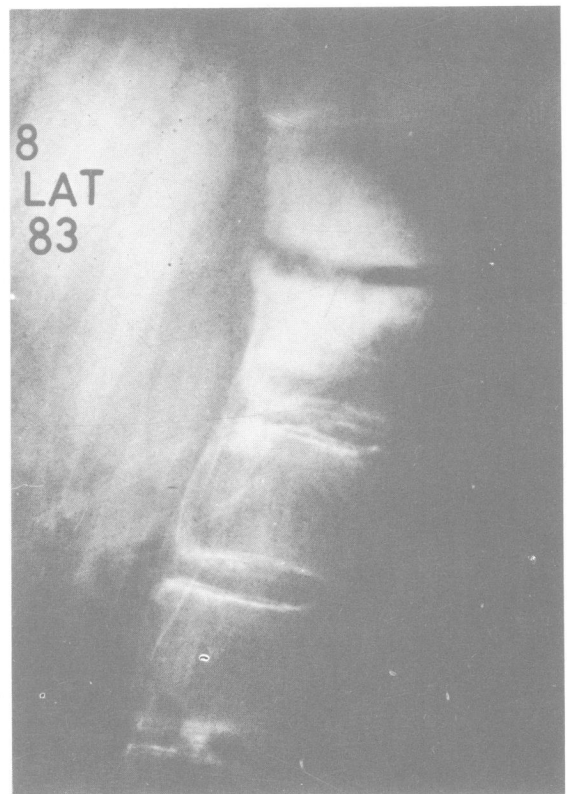

Figure 3B

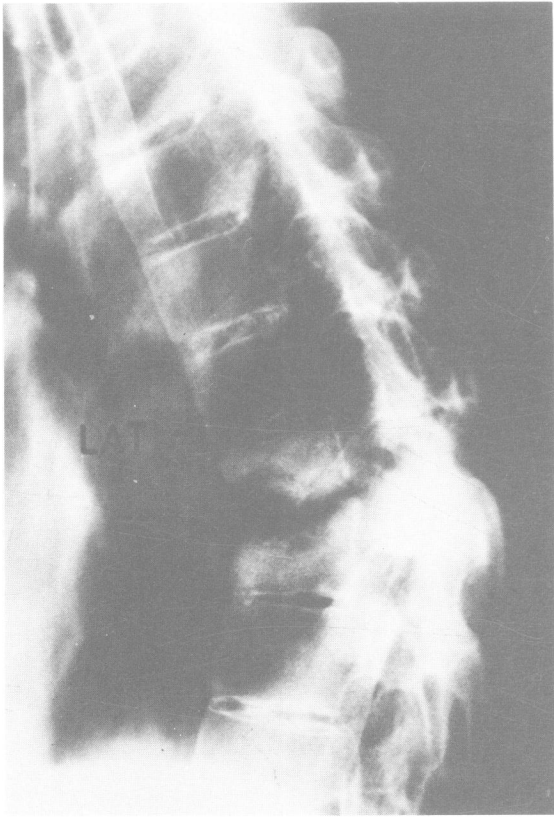

Figure 3C

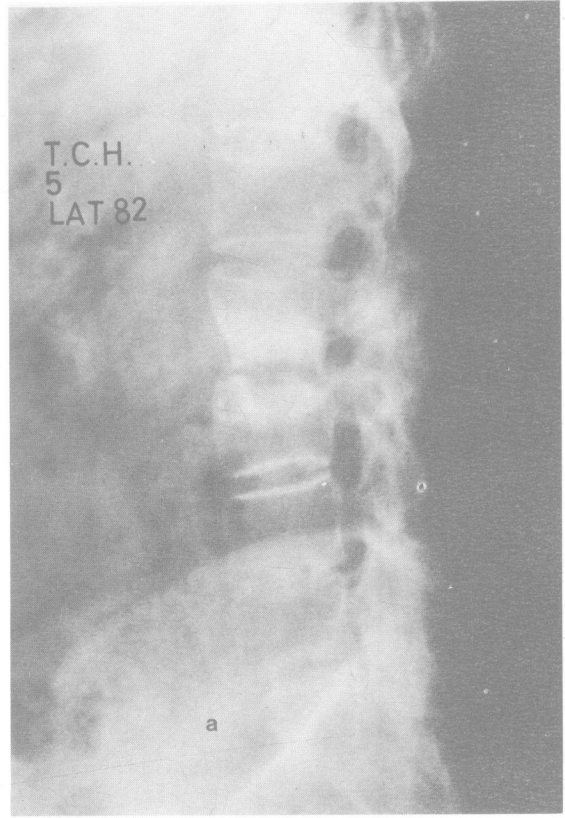

Figure 4A

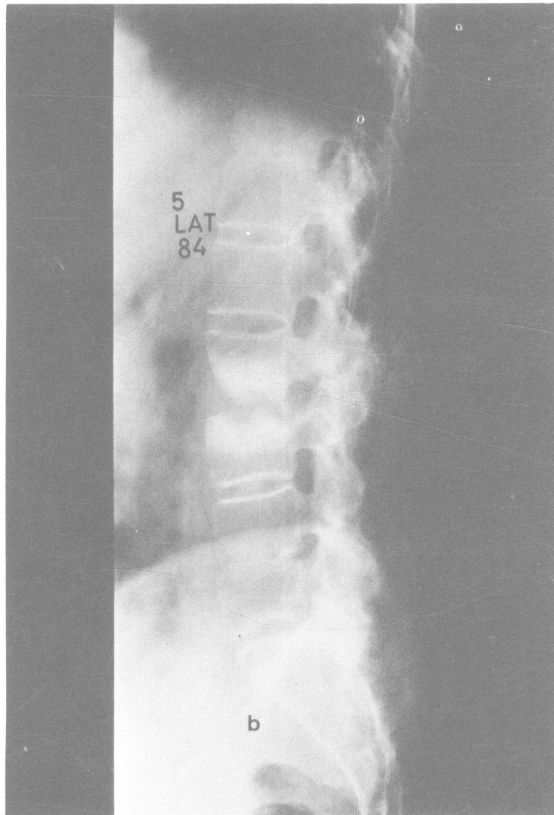

Figure 4B

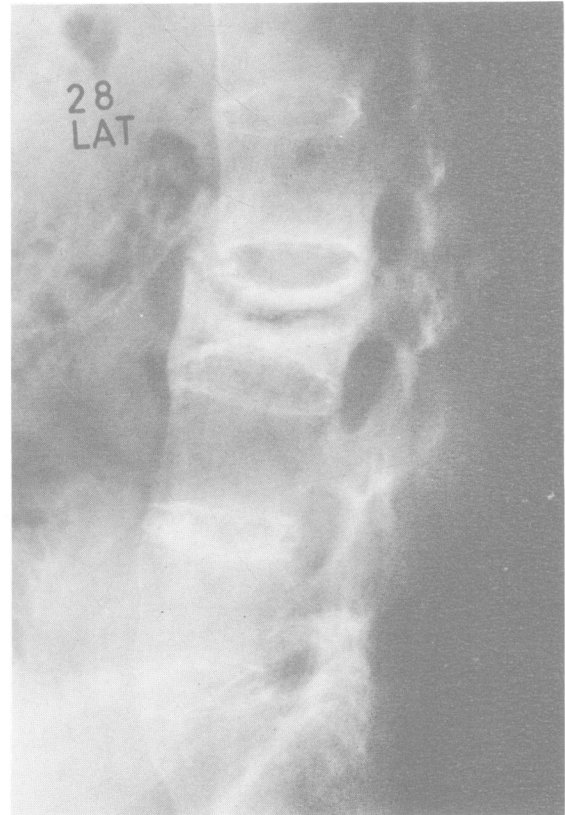

Figure 5





Figure 6

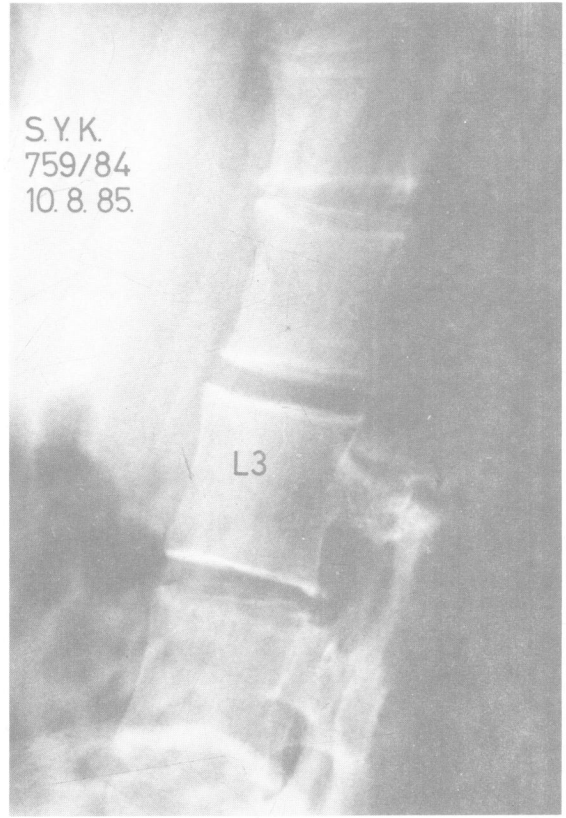

Figure 7



Figure 8

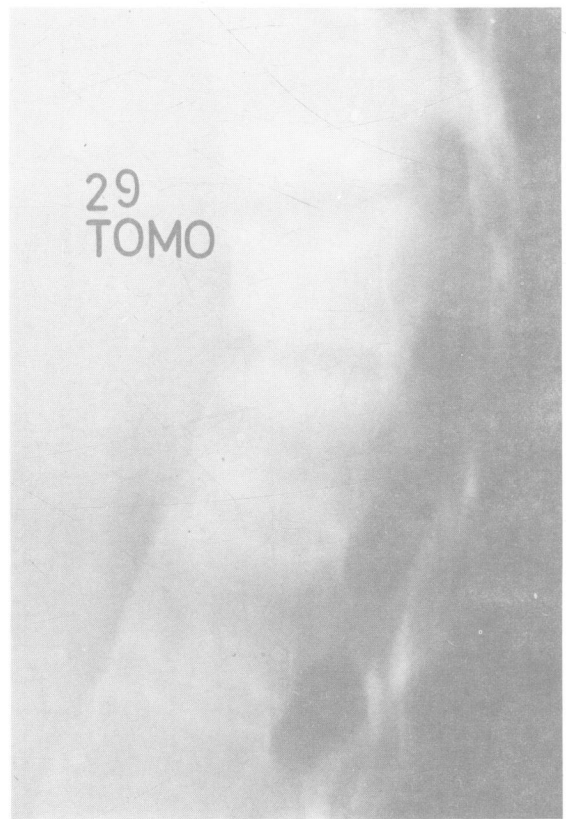

Figure 9

## LEGEND ON FIGURES

- Figure 1** (A) M/29 with pseudarthrosis at L2/3. Anterior spinal fusion was performed.  
(B) Film taken 4 years later showed solid fusion at L2/3, but another pseudarthrosis developed at L4/5.
- Figure 2** (A) M/39 had pseudarthrosis at L2/3 with slight osteolysis.  
(B) 7 years later there was complete healing of the L2/3 lesion. A new pseudarthrosis was slowly appearing at L1/2.
- Figure 3** Various degrees of anterior element osteolysis:  
(A) slight osteolysis, at L3/4, with moderate subjacent sclerosis. Posterior defect was obvious.  
(B) Mild – moderate osteolysis at T12/L1 with vacuum phenomenon.  
(C) Marked osteolysis at T9/10, with mild subjacent sclerosis, and kyphus deformity.
- Figure 4** (A & B) M/39 with pseudarthrosis at L2/3, showing progressive osteolysis over two years.
- Figure 5** Fracture across L3 vertebra developing into pseudarthrosis with vacuum phenomenon.
- Figure 6** M/48 with unfused facet joints at T11/12 and T12/L1 levels, had slight osteolysis of anterior portions of T12 and L1.
- Figure 7** M/25 with break across ankylosed posterior elements.
- Figure 8** Fracture across posterior elements of L2/3 followed by anterior osteolysis.
- Figure 9** F/40, with healed spondylodiscitis of L1 – L4 segments, developed osteolysis of T12/L1.



# FAMILY SCREENING IN ANKYLOSING SPONDYLITIS IN HONG KONG CHINESE

ERIC HO  
Department of Orthopaedic Surgery,  
University of Hong Kong,  
Queen Mary Hospital  
Hong Kong.

## INTRODUCTION

Ankylosing Spondylitis is an inherited disease. The pattern of inheritance has still not been fully worked out. Festenstein and Demant (1) advocated an autosomal dominant inheritance with 70% penetrance in male and 10% penetrance in female. Emery and Lawrence (2) proposed a multigenic pattern. A screening of 28 Chinese families with ankylosing spondylitis has been performed, in an attempt to study the pattern of inheritance of this disease in Hong Kong Chinese.

## MATERIALS AND METHODS

The family members of 28 Chinese patients were studied. A total of 201 family members were screened for the disease based on the New York Criteria (1968). All proven cases had xray changes of sacroiliitis.

Of 28 families studied, six families had 3 generations study, nineteen families had 2 generations study while three families had single generation study. The number of members in the family studied varied from three to twenty one. The smallest family studied consisted only the parents and their only son. The biggest family was a three generations study consisting of 21 members.

## RESULTS

Thirty five ankylosing spondylitics were present in the 28 families. Six were female giving a sex ratio of 29 to 6 (4.8 to 1) The youngest ankylosing spondylitic in our series is twelve year old.

In the biggest family there were 21 members in 3 generations of which 13 were B27 positive. Of these 13, only 2 had the disease.

Of 201 B27 tests, 117 had the antigen (58.2%) The incidence of family members having the disease is 53/201 (17.4%). The chance of B27 positive family member developing the disease is 35/117 (30%).

## REFERENCE

- 1) H.L.A. and H<sub>2</sub> Basic Immunogenetics. Biology and clinical Relevance. H. Festenstein and P. Demant, Edward Arnold.
- 2) A.E.H. Emery + J.S. Lawrence. Genetics of ankylosing spondylitis J. of Medical genetics 1967, 4, 249-244.
- 3) J. Mole, Ankylosing Spondylitis, Livingstone 1980.
- 4) E. Ho, S. Yuen, L.C.S. Hsu, S.P. Chow and J.C.Y. Leong, H.L.A. B27. An indicator for Ankylosing Spondylitis in Hong Kong Chinese. Pg. 15-18 Vol XXI No.1 June 1984. The Journal of the Western Pacific orthopaedic association.

## DISCUSSION

Comparing with Caucasians studies (3) most series gave a positive family incidence of 10-12% having spondylitis. The Hong Kong Chinese had a higher figure of 17.4%. Moreover, the chance of B27 positive family members that will develop the disease is higher in Hong Kong Chinese (30%) than most caucasians series (20%) Table (1). This probably reflects in part difference in environmental factors in the development of the disease. Ho (4) et al reported the very high correlation of B27 antigen with the disease (98.7%) and the low incidence of the antigen (3.7%) in Hong Kong Chinese. This gives a high relative risk factor (1976 times). It is not surprising that both the incidence of the disease in the family and the chance of B27 positive family members having spondylitis are higher in the Hong Kong Chinese.

## CONCLUSION

Family study of the B27 antigen and ankylosing spondylitis had rarely been done on the Chinese population. Our present study highly suggest the hereditary nature of both the antigen and the disease in Hong Kong Chinese. Because of the higher incidence of the disease in the family and the higher chance of disease development in B27 positive individuals, family study is of definite value in the early detection of the disease.

	Incidence of disease in family	Chance of B27 + family members having disease
Caucasian	10 - 12%	20%
Hong Kong Chinese	17.4%	30%

Table 1

I. Family study in Lam's family.

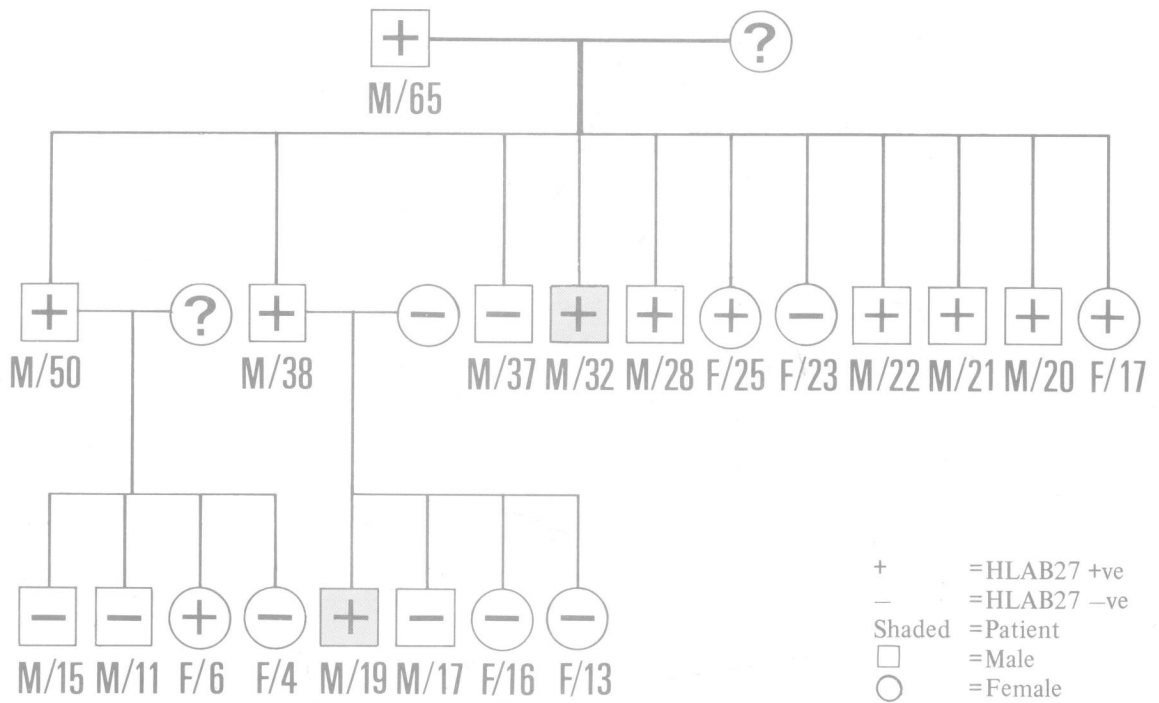

II. Tsang W.K. (Father) and Tsang K.H. (Son) both having Ankylosing Spondylitis.

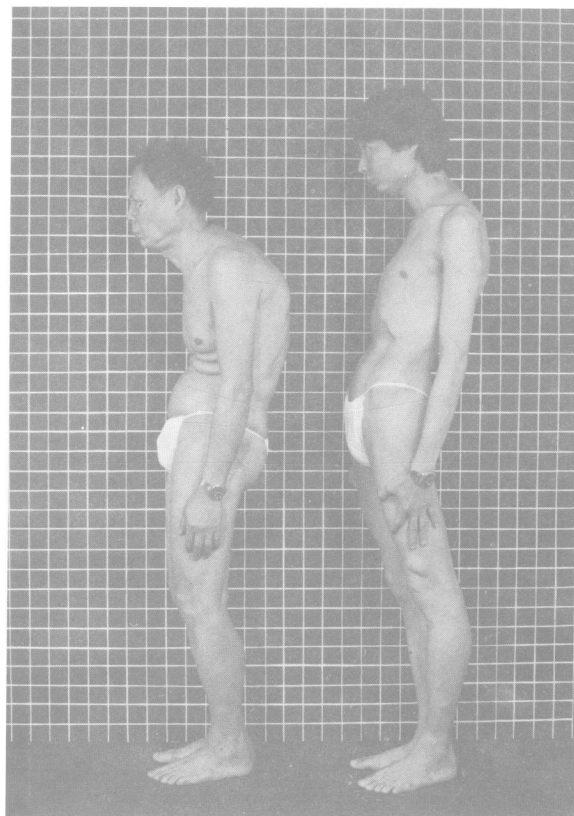

# CAUDA EQUINA SYNDROME IN ANKYLOSING SPONDYLITIS A CASE REPORT INCLUDING POST-MORTEM STUDY

Dr. Eric K.W. Ho\* FRCS (G)  
Dr. Mary Yuen\*\* MBBS (H.K.)  
Dr. Lily T. Ma\*\* Ph.D. (H.K.)  
Dr. Louis C.S. Hsu\* FRCS (E), FACS

*From the Department of Orthopaedic Surgery\* &  
Department of Pathology\*\*,  
University of Hong Kong,  
c/o Queen Mary Hospital,  
HONG KONG.*

*All Correspondence to—  
Dr. Eric K.W. Ho,  
Lecturer,  
Department of Orthopaedic Surgery,  
Queen Mary Hospital,  
Hong Kong.*

## ABSTRACT

The occurrence of cauda equina syndrome with long standing ankylosing spondylitis is a known association that may be overlooked or misdiagnosed because of its rarity. Less than 30 cases had been reported in the English literature. Necropsy findings were briefly described in only one case. Much emphasis had been placed on the associated posteriorly situated diverticula around the cauda equina region. The exact relationship of these diverticula to this syndrome remains unknown. We report a case with detail necropsy study of the spinal column.

## CASE REPORT

H.K.S. was 56 year-old Chinese gentleman with a known history of ankylosing spondylitis for 30 years. There was no history of irradiation therapy to the spine. He was fully ambulant until 4 months prior to admission in 1984. He developed mild weakness of both lower limbs. The weakness deteriorated and he became bed ridden one month before admission. At the same time, he noticed numbness of posterior aspects of both buttocks and he developed double incontinence. Examination during admission showed a round thoracolumbar kyphosis. There was weakness of both calf and ankle region (MRC grade 4). The ankle jerks were sluggish bilaterally. The Babinski response was equivocal bilaterally and the anal tone was absent. Sensory loss was demonstrable from lumbar five dermatome to include all sacral dermatomes bilaterally. The upper limbs were normal.

Plain Xray showed the classical changes of ankylosing spondylitis (Xray 1,2) with bamboo spine appearance and sacro-iliac joint fusion. A myelogram was attempted via the lumbar route but it failed. A cisternal puncture with myodil was performed. The thoracolumbar junction was screened with him in supine position. No evidence of diverticulum was present at the thoracolumbar junction. (Xray 3) A computerised tomographic study was performed for the thoracolumbar junction but no bony defects or erosion was seen in the posterior elements. (CT1) The

neurological deficit in his lower limb continued to deteriorate and he developed bilateral knee flexion contracture and bed sores. One month after admission, he developed massive upper gastro-intestinal bleeding and succumbed after an episode of aspiration pneumonia. A postmortem study was performed.

## POST-MORTEM FINDINGS

### Gross Pathology —

The spinal canal was of normal size. The posterior wall of the spinal canal was smooth with no evidence of erosion or diverticulum as contrast to other reports (figure 1). The vertebral bodies, lamina, transverse processes and spinous processes were intact. A hard calcified nodule which was likely to be due to previous haemorrhage with calcification, measuring 3.5 cm. x 2.5 cm. x 6 cm., was present around the transverse process of the lumbar three vertebra (Figure 1) without encroachment on the intervertebral foramen. There was no evidence of nerve root compression or inter-vertebral foramen narrowing.

The dura and arachnoid was not thickened and there was no adhesion between the spinal cord, the cauda equina and the arachnoid.

On opening the arachnoid, abnormalities of the cauda equina was seen (Figure 2). All the nerve roots

were pathologically narrower and more slender. The nerve roots on the left side of the cauda equina were apparently straight but those on the right side were all twisted and curled up. A large kink was also apparent in one of these curly nerve roots (Figure 3). The anterior spinal artery and the paired posterior spinal arteries were patent and showed no evidence of narrowing or atherosclerotic change.

#### Histology –

All levels of the available segment of spinal cord with haematoxylin and eosin and myelin stain (Solochrome, Cyanine and Luxol Fast Blue) showed marked demyelination in the pyramidal tracts, dorsal and lateral columns. The anterior horn was normal in appearance. No evidence of inflammation was apparent in the spinal cord and the arachnoid (Figure 4).

The nerve fibres in the nerve roots were irregular in size and some showed marked degeneration with thinning of the fibres and demyelination. All the Schwann cells had similar histological appearance and had numerous small vacuoles in their cytoplasm (Figure 5).

#### DISCUSSION

Bechterew (1) in 1893 speculated the association between ankylosing spondylitis and spinal meningitis. This was the first description between ankylosing spondylitis and the nervous system. The first description of this unique association was by Bowie and Glasgow (2) in 1961. Subsequently in a review of 45 patients with ankylosing spondylitis by Thomas et al (3), 10 had neurological symptoms and signs. Of these 10 cases discussed, 2 had cauda equina syndrome. Up till 1976, Hassan (4) reviewed this condition and a total of 24 cases had been reported. Our clinical findings were very similar to those described by Hassan (4) Matthews (5), Russel (6), Bowie and Glasgow (2), Goldenberg & Logothetis (7), Rosenbranz (8). All the patients were suffering from chronic inactive disease as in our case. Urinary problem was a very common complaint. It was present in 15 out of 24 reported cases [Hassan (4)]. Our case had double incontinence. Absence of ankle jerk was present in all reported cases. It was a constant sign that should make one suspect such a rare association.

The myelographic finding was variable. 6 out of 24 reported cases in the literature had normal myelograms [Hassan (4)]. The pathognomonic myelographic finding had been the presence of lumbar diverticula or cyst. However, since most of these patients had completely ossified posterior elements of the spine, it is doubtful whether such investigation should be performed. On the other hand, the C.T. scan could give the accurate information which could be missed if the supine films were not taken during myelographic examination. In our case, the lumbar myelogram failed, but both myelogram through cisternal puncture and C.T. scan showed no abnormalities around the thoracolumbar segment.

Up till now only 1 post mortem study had been reported on this condition [Matthew (5)]. He described the diverticula, but the exact role of them remained uncertain. These diverticula were distinctly absent in the whole spinal canal in our case. There was no arachnoid adhesions in Matthews (5) case and our study. However, he did not identify individual roots of the cauda equina because of their method of examination. Our study (Figure 3) clearly demonstrated the presence of abnormal kinked nerve roots. All the nerve roots were pathologically narrower and more slender. The normal anterior and posterior spinal arteries precluded to diagnosis of vascular impairment.

The histological section gave the final confirmation of diagnosis. Marked demyelination in pyramidal tracts, dorsal and lateral column correlated very well with the clinical picture. The vacuolation of the Schwann cell confirmed the degeneration process.

Since the basic pathology of this condition is demyelination and not cauda equina mechanical compression, it is obvious that decompressive laminectomy as suggested by some authors [Russell et al (60)] is not indicated. Electrical studies should be helpful in the diagnosis because of the demyelination nature of the disease.

#### LEGENDS TO FIGURES

- Figure 1** The upper half of the picture shows the longitudinal section of the vertebral column. Note the smooth anterior wall and posterior wall of the spinal canal on the left and right side respectively. The lower half of the picture shows the cross section of the L3 vertebra. A hard calcified nodule is present around the left transverse process (possibly due to previous bleeding in the psoas muscle).
- Figure 2** The cauda equina of this patient (on the right side) is conspicuously abnormal when compared with the normal cauda equina from an age-matched patient (left side). Note the curly appearance of the nerve roots and the large kink (pointed by the narrow) in the abnormal cauda equina.
- Figure 3** This is a higher magnification of the abnormal curly nerve roots and the kinking nerve root.
- Figure 4** This is a cross section of the spinal cord. The demyelinated tracts are shown as whitish areas in the picture (Stain : Luxol Fast Blue, x 21).
- Figure 5** This is a section of the nerve root showing numerous small vacuoles in the cytoplasm of the Schwann cell (Stain : Luxol Fast Blue x 400).
- Xray 1** Plain Xray (Antero-posterior view) of lumbo-sacral spine showing classical

changes of ankylosing spondylitis with bamboo spine appearance and sacroiliac joint fusion. A large calcified mass was present in the left psoas shadow.

**Xray 2**

Plain Xray (Lateral) of lumbo-sacral spine showing classical changes of ankylosing spondylitis with bamboo spine appearance. This is due to ossification of the anterior and posterior longitudinal ligament.

**Xray 3**

Myodil myelogram introduced through cisternal puncture. Screening of the patient in the supine position was performed.

Lateral Xray of thoracolumbar junction showed no evidence of diverticular. There was free flow of myodil within the spinal canal.

**C.T. 1**

This computerised tomographic scanning of the lumbar 1 vertebrae level showed changes of ankylosing spondylitis in the anterior and posterior elements. There is no evidence of bony defects or erosions in the posterior elements. No significant spinal stenosis is noted. Myodil contrast from previous study was seen posteriorly.

**REFERENCE**

1. Bechterew, W. Von: *Streifigkeit der Wirbelsaule und ihre Verkummung als besondere Erkrankungsform. Neurologisches Centralblatt.* 1893, 12 : 426-434.
2. Bowie, E.A. and Glasgow, E.L. *Cauda equina lesions associated with ankylosing spondylitis. Report of three cases. British Medical Journal.* 1961 July 1, 2, 24-27.
3. Thomas, D.J. et al.: *Nervous system involvement in ankylosing spondylitis. British Medical Journal.* 1974 January 1, 148-150.
4. Hassan, I. : *Cauda equina syndrome in ankylosing spondylitis : A report of six cases. Journal of Neurology, Neurosurgery, and Psychiatry.* 1976 38, 1172-1178.
5. Matthews, W.B. : *Neurological complications of ankylosing spondylitis. Journal of the neurological sciences.* 1968 6 : 561-573.
6. Russell, M.L. et al : *The cauda equina syndrome of ankylosing spondylitis. Annals of internal Medicine.* 1973, 78 : 551-554.
7. Goldenberg, G.J. and Logothetis J. *Neurological manifestations in two cases of ankylosing spondylitis, Lancet* 1961, I : 448-450.
8. Rosenbranz, W. : *Ankylosing spondylitis : Cauda equina syndrome with multiple spinal arachnoid cysts. Case report. Journal of Neurosurgery.* 1971, 34 : 241-243.

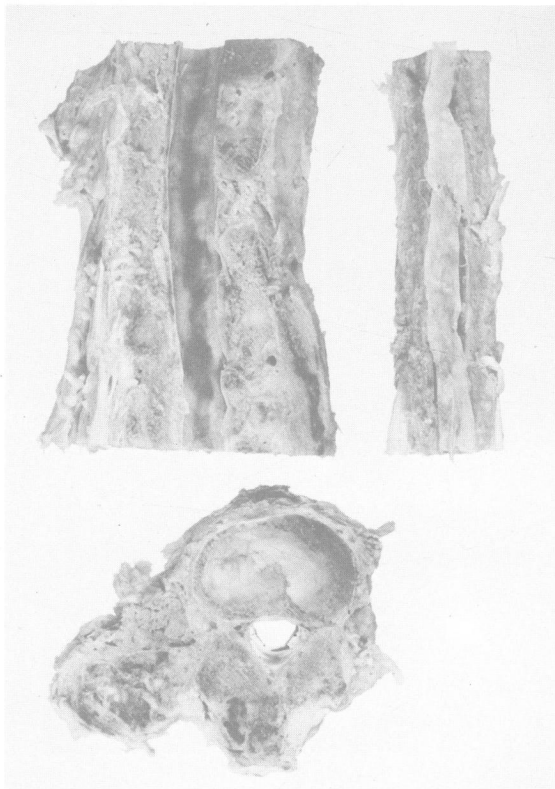

Figure 1



Figure 2



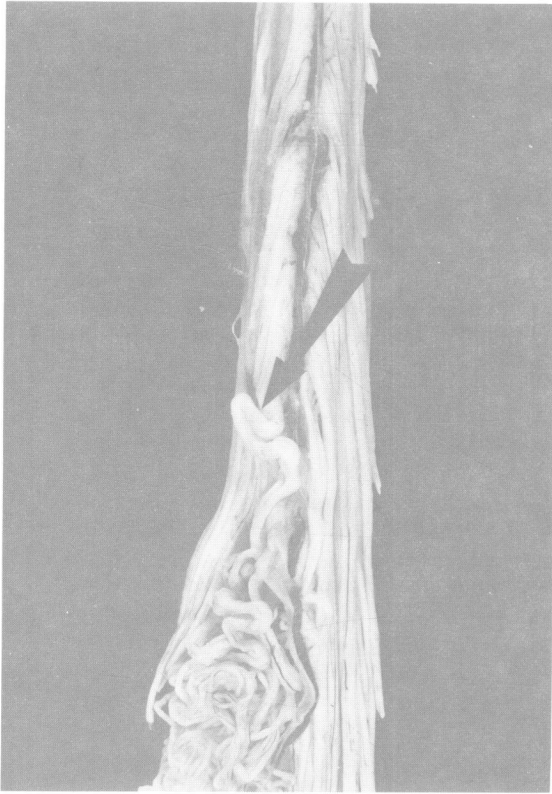

Figure 3



Figure 4

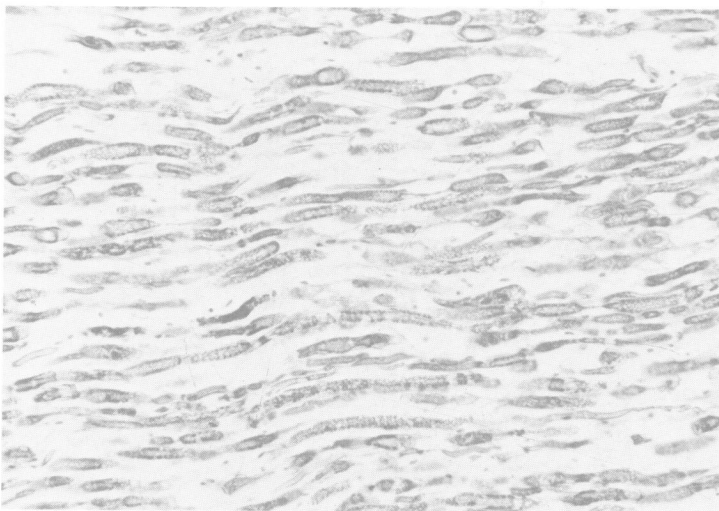
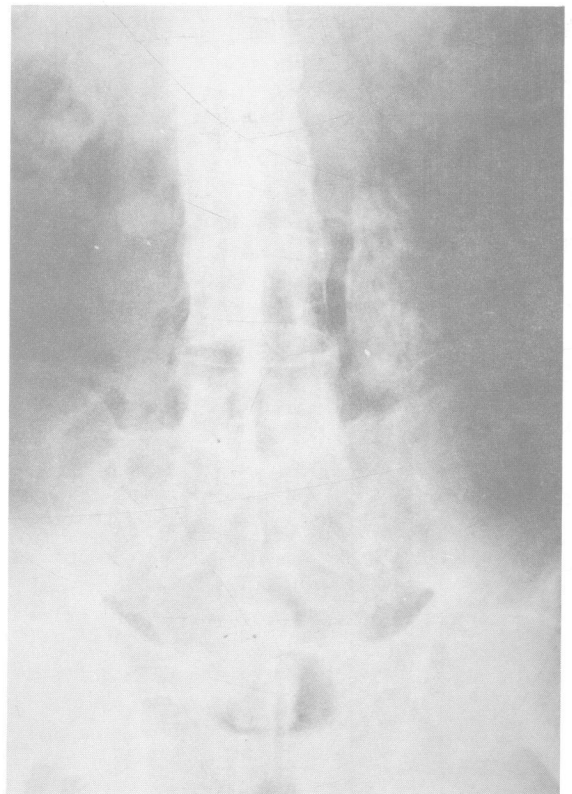
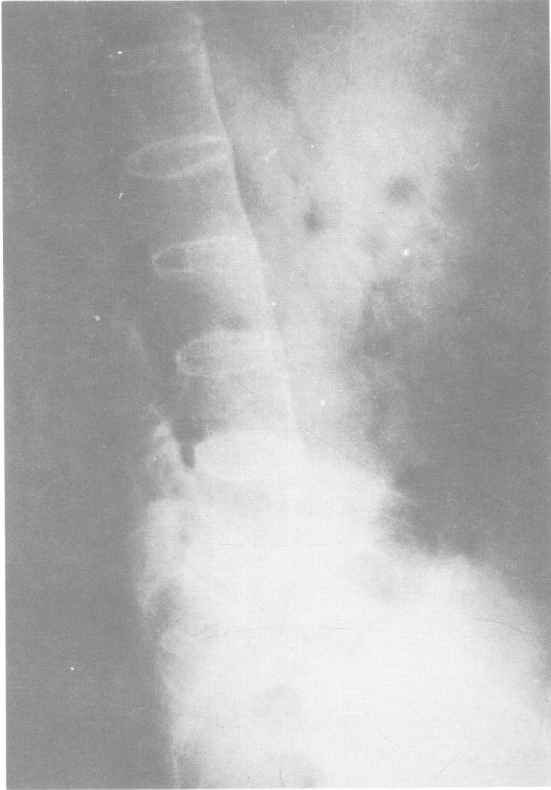

Figure 5



X Ray 1



X Ray 2

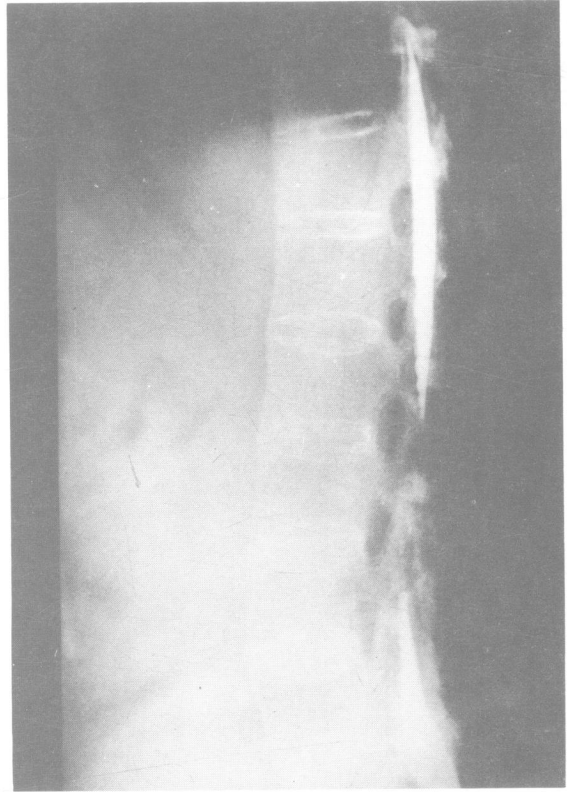

X Ray 3

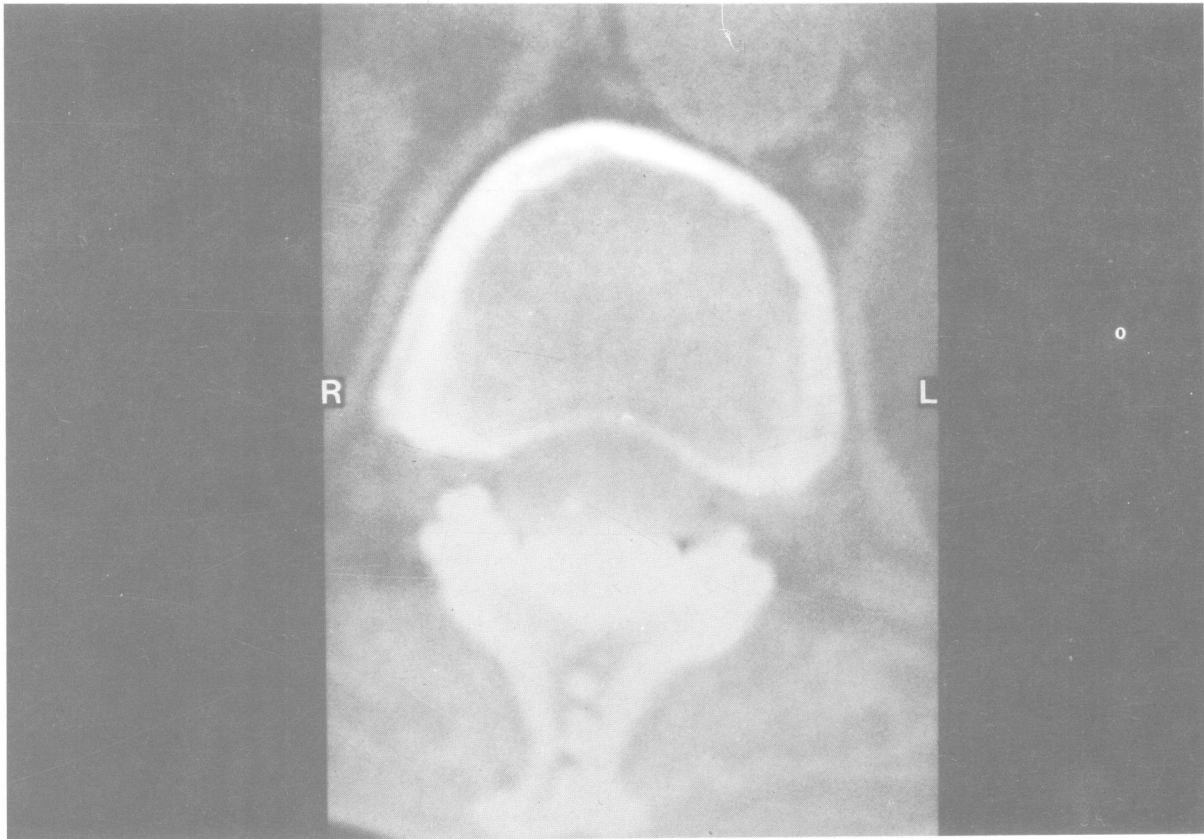

C.T.1



**TRAUMATIC TETRAPARESIS:  
A RARE NEUROLOGICAL COMPLICATION IN ANKYLOSING  
SPONDYLITIS WITH OSSIFICATION OF POSTERIOR  
LONGITUDINAL LIGAMENT OF THE CERVICAL SPINE**

\*Eric K. W. Ho, F.R.C.S. (Glas.)

\*\*John C. Y. Leong, F.R.C.S. (Ed.), F.R.C.S. (Eng.)

Department of Orthopaedic Surgery  
University of Hong Kong  
Queen Mary Hospital  
Hong Kong

\* Lecturer, Department of Orthopaedic Surgery, University of Hong Kong.

\*\* Professor & Head, Department of Orthopaedic Surgery, University of Hong Kong.

**Reprint request to:**

Professor J. C. Y. Leong, Department of Orthopaedic Surgery,  
University of Hong Kong, at Queen Mary Hospital, Hong Kong.

**ABSTRACT**

A unique case of ankylosing spondylitis with ossification of the posterior longitudinal ligament affecting the cervical spine is described. Its clinical presentation as traumatic tetraparesis is interesting. The cause of tetraparesis in this patient is investigated with the help of the C. T. Scan. The literature on the simultaneous involvement of the cervical spine by ankylosing spondylitis and ossification of the posterior longitudinal ligament was reviewed.

**KEY WORDS**

ANKYLOSING SPONDYLITIS  
OSSIFICATION OF THE POSTERIOR  
LONGITUDINAL LIGAMENT  
TETRAPARESIS

**INTRODUCTION**

Ossification of the posterior longitudinal ligament of the cervical spine is an uncommon clinical problem. It is seen most frequently in the Japanese. Izawa<sup>1</sup> reported an incidence of 3% in the adult Japanese population. Reports outside of Japan have been sporadic and few. Kurokawa<sup>2</sup> in a review of 498 cervical roentgenograms of Hong Kong Chinese over 40 years of age reported 9 cases of ossification of the posterior longitudinal ligament, giving a roentgenological incidence of 1.8%. The ossification may lead to narrowing of the cervical canal thus causing spinal cord compression. The occurrence of ossification of the posterior longitudinal ligament in patients with ankylosing spondylitis is a unique combination. Tsuyama et al reported that only 2% of the patients with the former disease was simultaneously affected by ankylosing spondylitis<sup>2</sup>. However no detailed information of the clinical presentation was given. We here report a case of ossification of the posterior longitudinal ligament of the cervical spine in a patient with ankylosing spondylitis who presented to us as traumatic tetraparesis.

**CASE REPORT**

A 66 year old man presented with traumatic tetraparesis after a fall with mild hyperextension injury to the neck. He had a known history of kyphotic deformity of the back since 30 year of age due to ankylosing spondylitis. Further questioning revealed that he also noticed progressive stiffness of his neck in the recent 10 years. Initial examination showed that there was kyphosis of the thoracic spine with forward flexion deformity of the cervical spine. There was complete absence of neck and back movement in all directions. The range of movement of the hips and shoulders were normal. There was mild tenderness over the spinous process of C6. Total tetraparesis was noted with muscle power being grade one in all four limbs. Sensory testing showed hypoaesthesia below C6 region. There was loss of anal reflex. Urinary retention was demonstrable.

Radiological examination of the cervical spine showed marked calcification of the anterior longitudinal ligament. There was extensive ossification of the posterior longitudinal ligament from C2 to C7. (Fig. 1). Generalised osteoporosis was noted. Ossification of the posterior longitudinal ligament was also clearly demonstrated on the tomogram (Fig. 2). Radiological examination of the lumbar spine and pelvis showed fusion of the sacroiliac joints (Fig. 3). There was also bamboo spine appearance of the skeleton which was pathognomonic of patients with ankylosing spondylitis (Fig. 4). This radiological change is also noted in the cervical spine (Fig. 1). A

computerised axial tomogram was performed confirming the presence of marked ossification of the posterior longitudinal ligament with compression of the cervical cord (Fig. 5). The cervical canal was narrowed to less than half of its cross-sectional area in some places. Fracture or haematoma collection was absent. Neither was there evidence of fracture of the ossified posterior longitudinal ligament. Concomitant calcification of the anterior longitudinal ligament was confirmed on the C. T. Scan. HLA B27 testing was positive.

For the initial management of this patient, a soft neck collar was prescribed. The tenderness in the neck subsided completely after 3 weeks of treatment. There was slow but steady progress noted, and the muscle power in the lower limbs became Grade 3 after 2 months. Upper limb assessment showed that the elbow extension was Grade 4 and that of flexion was Grade 5. Unfortunately the patient developed gastrointestinal bleeding and severe haematuria 2½ months after admission. He died despite active resuscitations. The cause of his death was probably not related to ankylosing spondylitis and ossification of posterior longitudinal ligament. No post-mortem study was done because his family strongly refused.

## DISCUSSION

Simultaneous involvement of the cervical spine by ankylosing spondylitis and ossification of the posterior longitudinal ligament as illustrated by this patient is an extremely rare clinical entity. Even in Japan, where the incidence of OPLL is exceptionally high compared with the rest of the world, the association of the disease with ankylosing spondylitis was reported to be only 2%<sup>2</sup>. Similar association had only been reported in one patient in the European literature up to 1983<sup>5</sup>. The second interesting feature demonstrated by this case is that it presented as traumatic tetraparesis with rapid recovery.

The diagnosis of ankylosing spondylitis in our patient is certain. All the clinical and radiological findings are in favour of the diagnosis. There was typical bony ankylosis in the cervical spine as well as other parts of the spine. The fusion of the sacroiliac joint is also characteristic of the disease. Neurological complications such as tetraparesis occurring in such patients had been reported<sup>4</sup>. These patients are prone to fracture of the cervical spine after minor injury, the reasons being that there is generalised osteoporosis; besides, the rigid spine cannot yield to stress. In a review article describing 20 cases of fracture of the cervical spine in patients with ankylosing spondylitis, Woodruff noted that there was a high incidence of the fracture involving the C5 and C6 regions<sup>4</sup>. Our patient developed tetraparesis following mild hyperextension injury to the neck. Though the pattern of neurological deficit corresponded to that of a lesion in the C6 vertebra, in our patient there was no evidence of fracture of the cervical spine both on radiological as well as on computerised tomographic examination.

The presence of extensive ossification of the posterior longitudinal ligament can narrow the cervical canal significantly. This is well demonstrated in the C. T. Scan of this patient. In the presence of such narrowing, the slightest amount of oedema or haematoma subsequent to insignificant trauma may lead to serious neurological sequelae even in the absence of demonstrable fracture. With the resolution of the haematoma or subsidence of oedema in the cord, early recovery of the neurological deficits may be possible. We believe that this is the basic pathology affecting the cervical cord in this patient.

The routine use of C. T. Scan in conjunction with conventional radiographic examination in the evaluation of patients with spinal trauma had been strongly recommended by Post et al<sup>3</sup>. The information obtained by C. T. Scan provided valuable guidance for patient management. The exclusion of cervical spine fracture by C. T. Scan enable us to encourage early ambulation. This would prevent chronic sequelae such as contractures and ankylosis which are already causing much disability in our spondylitic patient.

## SUMMARY

This report illustrates the acute development of tetraparesis after a relatively minor trauma in a patient with ankylosing spondylitis whose cervical spine was also affected by ossification of the posterior longitudinal ligament. The dual lesions affecting the cervical spine is a clinical rarity. Interesting C. T. Scan findings include the absence of fracture both in the cervical spine and in the ossified posterior longitudinal ligament. The exact mechanism producing tetraparesis in our patient remained obscure. The possibility of post-traumatic oedema or haematoma compressing on the spinal cord; the early resolution of which lead to early disappearance of the neurological deficits seems a logical explanation.

**Figure 1** X-ray cervical spine showing extensive calcification of the posterior longitudinal ligament and 3 levels of the anterior longitudinal ligament.

**Figure 2** Tomogram of the cervical spine showing clearly the extensive ossification of the posterior longitudinal ligament.

**Figure 3** X-ray pelvis showing bilateral sacroiliac joint fusion classically seen in patients with ankylosing spondylitis.

**Figure 4** X-ray lumbar spine showing the classical bamboo spine in advanced ankylosing spondylitis.

**Figure 5** C. T. Scan of the C6 region showing severe narrowing of the spinal canal by the ossified mass of the posterior longitudinal ligament.

## REFERENCES

1. Izawa K: *Comparative Roentgenographic Study on the Incidence of Ossification of the Posterior Longitudinal Ligament and Other Degenerative Changes of the Cervical Spine among Japanese, Koreans, American and German.*  
*Nippon Seikeigeka Zasshi* 54: 461-471 1980
2. Japanese Ministry of Health Public and Welfare, the Investigation Committee on OPLL of the Japanese – *The Ossification of the Posterior Longitudinal Ligament of the Spine. (OPLL)*  
*J. Jpn Orthop. Ass:* 55, 425-440 1980
3. Post M J D, Green B A, Quencer R M, Stokes N A, Callhan R A and Eismont F J: *The Value of Computerised Tomography in Spinal Trauma.*  
*Spine* Vol. 7 Number 5 417-431 1982
4. Woodruff F P and Dewing S B: *Fracture of the Cervical Spine in Patients with Ankylosing Spondylitis.*  
*Radiology* Vol. 80 17-21 1963
5. Yagan R, Khan M A and Bellon E M: *Spondylitis and Posterior Longitudinal Ligament Ossification in the cervical spine.*  
*Arthritis and Rheumatism* Vol. 26 Number 2 226-230, 1983.



Figure 1

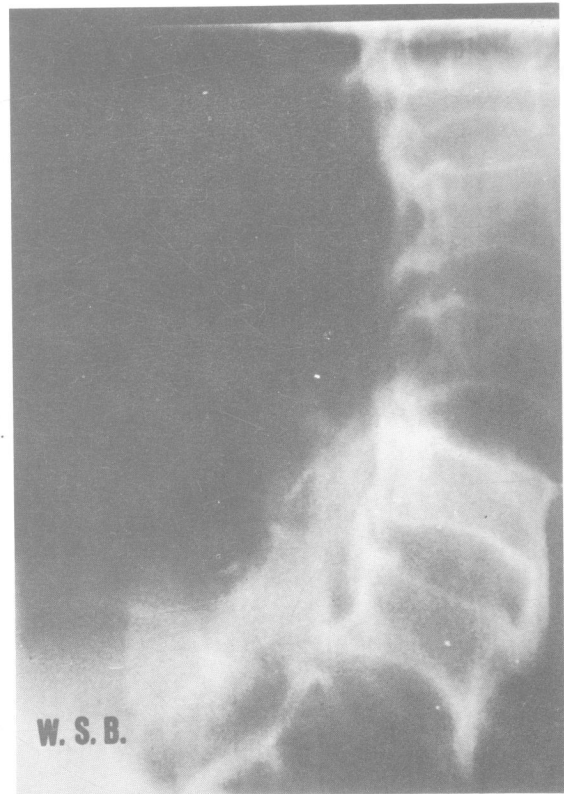

Figure 2



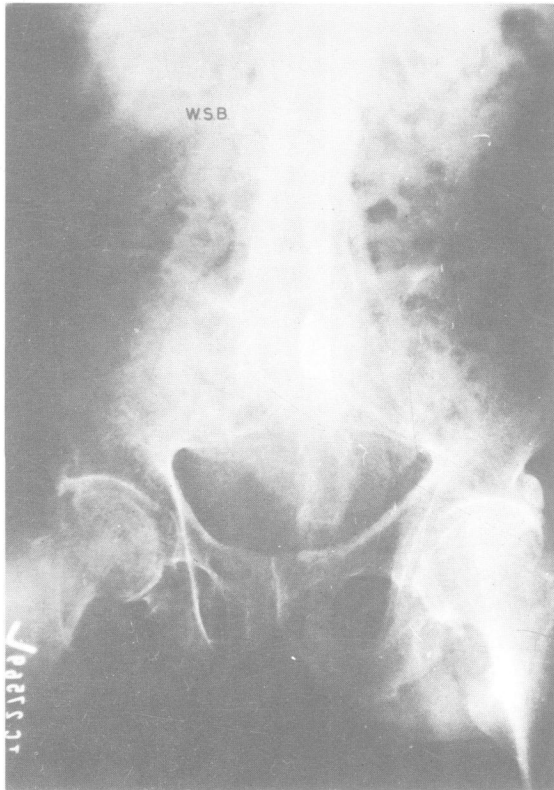

Figure 3

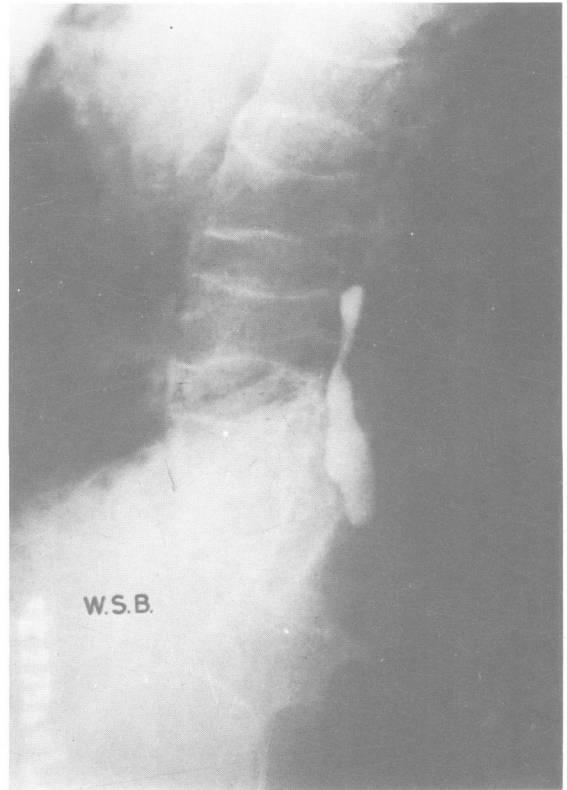

Figure 4



Figure 5

## OCCUPATIONAL THERAPY DEPARTMENT

### Study of Functional Disabilities of Ankylosing Spondylitic Patients

K. Chan, E. Ho  
Duchess of Kent Children's Hospital, Hong Kong

Ankylosing Spondylitis is a rheumatic disease that affects the spine. Patients often complain of buttock and low back aches. These aches may initially be transient but soon become more persistent leading to some degrees of stiffness of the spine. As time passes, stiffness increases and extends to other joints. In advanced cases the head, neck, entire spine, hips and shoulders are stiff and fused. By this stage mobility is greatly diminished. The functional ability may also be affected.

A study is carried out aiming at assessing the functional abilities of patients suffering from ankylosing spondylitis.

#### METHOD

A random 101 patients is selected from the Ankylosing Spondylitic Clinic at Duchess of Kent Children Hospital. This includes 96 males and 5 females. The youngest patient is 16 years old and the oldest is 59 years old with the mean age of 33.

#### PROCEDURE

Each patient is interviewed and assessed. They are chosen at random. Each patient had assessment on 100 items covering the following topics:

- |                         |                        |
|-------------------------|------------------------|
| 1) Ambulation           | 6) Eating              |
| 2) Transfer             | 7) Personal hygiene    |
| 3) Household activities | 8) Manipulation        |
| 4) Dressing             | 9) Communication       |
| 5) Bathing              | 10) Leisure activities |

Each item is graded into four levels of performance:

- 1) Independence
- 2) Minimally impaired
- 3) Moderately impaired
- 4) Maximumly impaired

#### Result of the Study:

##### 1) Ambulation/Transport

Of the 10 items assessed, 76% are graded under independence, 11% minimally impaired, 3% moderately impaired. None of the items is graded under maximumly impaired. In general ankylosing spondylitic patients are ambulatory and are able to go out using some form of public transport.

##### 2) Transfer

9 items are assessed. 73% are graded independence, 19% minimally impaired, 6% moderately impaired and 2% maximumly impaired. The greatest difficulties patients have

are in getting up from low furniture. This requires fairly good range of motions in hip joints.

##### 3) Household activities

18 items are assessed. 90% are graded independence, 7% minimally impaired, 2% moderately impaired and 1% maximumly impaired. The commonest difficulties, patients encountered are child lifting/carrying and cleaning windows which require pain free and quite mobile joints.

##### 4) Dressing

12 items are assessed for upper and lower limb dressing, 84% are graded independence, 10% minimally impaired, 4% moderately impaired and 4% maximumly impaired. It is found that all patients manage upper limb dressing without much difficulty. The maximumly involved dressing activities all fall into lower limb dressing items such as putting on socks and tying shoe-lace.

##### 5) Bathing

4 items are assessed, 84% are graded independence, 10% minimally impaired, 5% moderately impaired and 2% maximumly impaired. The difficulties lie in washing feet and toes.

##### 6) Hygiene

10 items are assessed, 93% are graded independence, 4% minimal impaired, 2% moderately impaired and only 1% maximumly impaired. A few patients seen have great difficulty cutting their toe nails.

##### 7) Eating

6 items are assessed, 99.4% are graded independence and 0.6% are minimally impaired. None of the item is graded moderately and maximumly impaired.

##### 8) Manipulation

21 items requiring finger manipulative skills are assessed, 99.9% are graded independence and 0.1% is minimally impaired. None of the item is graded moderately and maximumly impaired.

##### 9) Reach

This is to assess patients' ability to retrieve dropped objects from floor, 65% are graded independence, 22% minimally independence, 8% moderately impaired and 5% maximumly impaired.



## COMMUNICATION

5 items are assessed. All items are graded 100% independence.

## LEISURE ACTIVITIES

4 items are assessed, 70% are graded independence, 11% minimally impaired, 11% moderately impaired and 9% maximumly impaired.

## DEVICES PRESCRIBED

34 aids are prescribed for 18 patients. They are as follows:

sock aid	14
long handle reacher	4
long handle brush	4
long handle shoe horn	4
adapted toe nail clipper/file	4
dressing stick	2
window cleaner	1
raised toilet seat	1

## DISCUSSION

The 101 patients in this study are chosen at random. They vary in severity from minimally involved to severely involved. Majority of them have involvement more than one joint. The lower lumbar spine and the hips are the commonest sites of involvement. The upper limbs are usually spared. This explains why patients functions extremely well in areas of finger manipulation, upper limb dressing, eating and communication.

All of the 101 patients are ambulatory. Only a few need a walking stick. All of them are able to manage public transport. Majority of them prefer to use light buses than to public buses for reasons of less jerky and more time allowed by the drivers in getting on and off the light buses. The more severely involved patients have to rely on taxis.

18 patients require aids to carry out part of their daily living activities. Those 18 patients belong to the severely involved group. Many of them have had long history of Ankylosing Spondylitis. No proper medical treatment was given prior to their attending the Ankylosing Spondylitic Clinic, resulting in stiff and ankylosed joints. Of the 34 aids prescribed, majority being lower extremities dressing and washing aids. This closely correlates hips and spines being the commonest sites of involvement.

Of the 101 patients interviewed, majority of them have to give up vigorous sports such as soccer, basket-ball and hiking. This is mainly due to pain, joint stiffness and low endurance. However this does not seem to have great hindrance on most of the patients for reasons that most of them do not engage in vigorous sports. Majority of them are from the labouring class. They have to work long hours, do not have much leisure time for sports. These patients

prefer less vigorous leisure activities such as watching T.V., short stroll, movie going, playing chess, cards or mahjong games.

## CONCLUSION

This study suggests that ankylosing spondylitic patients who have been diagnosed and received treatment in the initial stage function normally in their daily living activities, work as well as leisure activities. They may have a few bad days in a year with onset of acute pain. Usually this can be controlled with medication, and they are able to lead a normal life.

The really disabling patients who accounts for about 10% of the population are the ones who has the disease for a number of years but has not sought treatment. By the time they came to our clinic they have already developed deformed and stiff joints. They are hindered in their functional abilities and often times required aids. These patients are ignorant about the disease and where to seek medical treatment. Had they sought treatment earlier, they probably be spared of the deformities developed in the later stage.

With the establishment of the Ankylosing Spondylitic Service at Duchess of Kent Children's Hospital, one can aim at preventive medicine. This disease can be detected much earlier and proper treatment can be given. At the same time one can educate patients about the course of the disease, the importance of good body mechanics, remedial exercises and work environment to conserve mobility.

By doing this, one may hope to help the ankylosing spondylitic patients to lead a normal and independent life.

**OCCUPATIONAL THERAPY**  
**Activities of Daily Living Evaluation Form**

Name:

Hospital No.:

D.O.B.:

Diagnosis:

Date:

LEVEL					LEVEL						
INDEPENDENT/ INTACT	MINIMAL IMPAIRED	MODERATE IMPAIRED	MAXIMUM IMPAIRED		INDEPENDENT	MINIMAL IMPAIRED	MODERATE IMPAIRED	MAXIMUM IMPAIRED			
				Use elevator	AMBULATION/TRANSPORT				Pullover	DRESSING	
				Use public transport					Shirt		
				Use Taxi					Pants		
				Household ambulation					BRA		
				Manipulate wheelchair					Socks/stocking		
				Walk on level ground					Shoes on/off		
				Up steps					Tie shoelace		
				Down slope					Shoe buckle/snap		
				Curbs					Button		
				Outdoor ambulation					Snaps/hooks		
									Zipper (front/back)		
									Brace on/off		
									Belt		
				Up from bed	TRANSFER					BATH	
				Up from easy-chair							
				Up from straight back chair							Upper extremity
				Up from couch							Lower extremity
				In/out of bath tub							Feet
				In/out of shower							Back
				Into car							
				Out of car							
				Floor to chair	HOUSEHOLD ACTIVITIES				Wash hands	HYGIENE	
				Up/down from toilet							Wash face
											Wash hair
				Carry objects							Comb/brush hair
				Use can opener							Brush teeth
				Cut with cleaver							Shave
				Cooking							Toiletting (clean self)
				Wash dishes							Adjust clothes after toiletting
				Dusting							Female hygiene
				Sweep floor							Cut/file nails
				Clean windows						EATING	
				Wash clothes					Chopsticks manipulate		
				Hang clothes to dry					Hold bowl		
				Dispose garbage					Drink from glass		
				Ironing					Drink from cup		
				Change/make bed					Uses spoon/fork		
				Simple home repair					Cut c knife		
				Thread needle							
				Sew button							
				Grocery shopping							
				Child care (carrying/ lifting)							

**OCCUPATIONAL THERAPY**  
**Activities of Daily Living Evaluation Form**

LFVLL					LIVLI					
INDEPENDENT/ INTACT	MINIMAL IMPAIRED	MODERATE IMPAIRED	MAXIMUM IMPAIRED		INDEPENDENT	MINIMAL IMPAIRED	MODERATE IMPAIRED	MAXIMUM IMPAIRED		
				Door knobs	MANIPULATION				Endurance	REACH
				Light-switch					Stability	
				Drawers					Retrieve dropped objects	
				Clothes from closet					R Forward distance	
				Scissors					L Forward distance	
				Wind watch					R Height distance	
				Handle money					L Height distance	
				Open envelope					R Side distance	
				Turn key					L Side distance	
				Open pop cans					Strength LIFT (1b)	
				Open can lids						
				Turn facet on/off						
				Wring towel						
				Squeeze toothpasts					Speech	
				TV knobs					Writing	
				Paper clip					Reading	
				Padlock					Telephone (desk)	
				Pen pencil					Telephone (public)	
				Unscrew/screw jars						
				Unwrap small package						
				Manipulate safety pins						
								Television	LEISURE	
								Movies		
								Short walk/stroll		
								Others		

Comments/Recommendation

Devices/Aids prescribed

**PHYSIOTHERAPY IN ANKYLOSING SPONDYLITIS  
AT THE DUCHESS OF KENT CHILDREN'S HOSPITAL**

D. Wong, J. M. Bourne, E. Ho  
Duchess of Kent Children's Hospital, Hong Kong

**INTRODUCTION**

Physiotherapy plays an important part in the overall management of patients with Ankylosing Spondylitis (A.S.). The majority of patients find that regular exercise relieves pain and stiffness and, especially if given in the early stages of the disease, will help to maintain a good overall posture.

At the Duchess of Kent Children's Hospital we assessed 66 inpatients, admitted from July 1983 to February 1985, between the ages of 17 and 61 years with a mean age of 31 years. The ratio of male to female was 63:3. On admission the assessment included an objective examination of peripheral and spinal joints, and chest expansion, and a subjective assessment of joints previously involved, exercise tolerance and any benefit gained from previous physiotherapy treatment or acupuncture. We also noted how well the patient was able to squat – an important factor in Hong Kong where Asian Style squatting toilets are still found in some homes.

**OBJECTIVE EXAMINATION**

**a) Peripheral Joints**

Joint	Affected Now	Previously Affected
Hip	91%	70%
Knee	41%	38%
Ankle	18%	20%
Shoulder	65%	17%
Elbow	1.5%	0%
Wrist	1.5%	1.5%
Hand	3%	1.5%

The following operations had been performed which affect the range of hip movement and pain felt:

Bilateral total hip replacements	6
Unilateral total hip replacements	3
Arthrodesis of the hip joint	1
Resection of the femoral head	1

**b) Spinal Joints**

All patients had involvement of the sacroiliac and spinal joints, the pattern of mobility is as follows:

Mobile Thoracic, Lumbar and Cervical	36%
Mobile Cervical Spine only	44%
Completely Rigid Spine	6%

**c) Chest Expansion**

The chest expansion was measured at nipple level from full expiration to complete inspiration. The range was from no movement at all to 4 cm. (taken to the nearest 0.5 cm.) (Fig. 1).

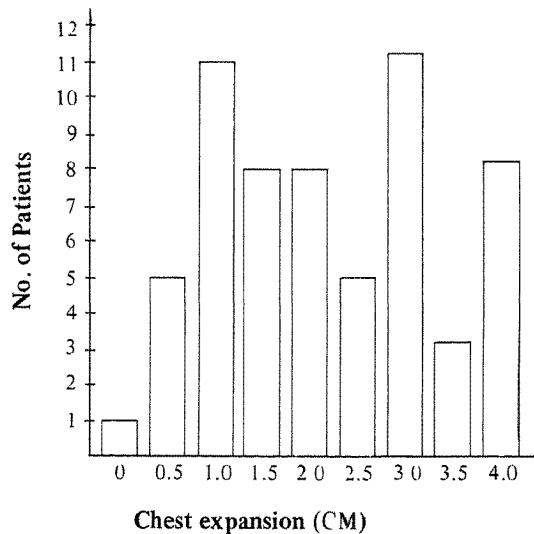

Fig. 1 Frequency distribution of chest expansion in 66 patients with Ankylosing Spondylitis

When measuring chest expansion with a tape measure the accuracy of the measurement will always be in doubt as on full inspiration there is contraction of the muscles of the axillary wall, which will affect the reading.

For comparison, 20 male subjects were taken with the same age limit as the A.S. patients and with no known chest injury or disease, and who do not engage in competitive sport. We measured the chest expansion in the same manner as the A.S. group.

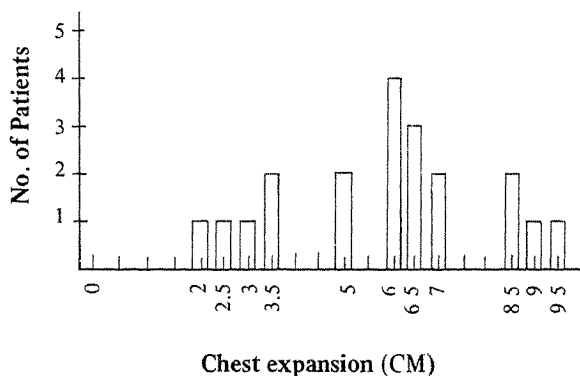

Fig. 2 Frequency distribution of chest expansion in 20 male subjects.

### SUBJECTIVE EXAMINATION

#### WALKING ABILITY

The patient was asked for what distance he could walk before having to stop to rest either because of pain or tiredness. This ranged from a few feet to an unlimited distance, ie. where the patient feels that his walking ability is not affected by his disease.

Twenty-two patients said that they could walk for an unlimited distance, whilst others described being able to walk for "at least a few hours". Two were limited by shortness of breath.

The number of flights of stairs the patient could manage was also noted (Fig. 3)

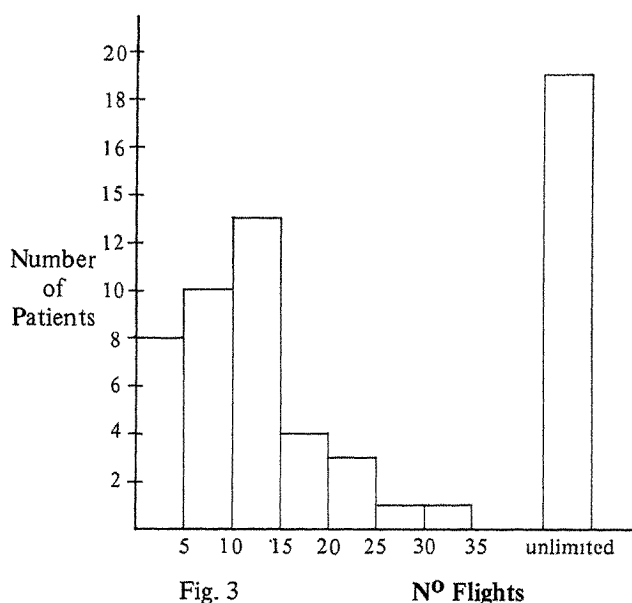

Fig. 3 Nº Flights

Out of 66 patients, only 16 were able to do a full squat. This was limited by pain and stiffness.

Only 9 patients needed a walking aid: 2 used bilateral crutches, and 7 used a single stick.

We then noted which patients had received previous physiotherapy treatment or acupuncture, and if either of these gave relief of symptoms.

	R	With Benefit	No Benefit
Physiotherapy	31	21	9
Acupuncture	13	6	7

### TREATMENT

The assessment enabled us to evaluate at which stage of the disease the patient was; acute, subacute or chronic. In the acute stage the aims of physiotherapy to relieve pain, maintain range of movement and function, maintain chest expansion and prevent the development of deformities. During the subacute/chronic phase we aim to increase the range of movement and improve muscle power, as well as advise the patient about home management.

There are various methods to fulfill these aims, Moist heat (hot packs), transcutaneous nerve stimulation (TNS) and hydrotherapy relieve pain and induce relaxation. Mobilization exercises are performed to improve mobility of the joints and increase exercise tolerance. Breathing exercises are also given to maintain chest expansion and vital capacity. Exercise is aimed at encouraging extension, especially of the spine, hip and knee joints to prevent flexion deformities. When the range of movement has been gained, strengthening exercises can commence utilizing sandbags, weights, spring and pulleys.

The patients here are given a daily group therapy session as well as 2 sessions of hydrotherapy and an individual exercise program for the patient to work on his own. We encourage them to play games such as basketball and join in the swimming sessions at the PHAB club in the summer.

Besides exercise, advice is given about posture at work, rest and sleeping. We stipulate that they sleep on a firm mattress, avoid soft chairs and prone lie at least half an hour every day on a firm surface. All these are to avoid prolonged flexion of the spine. We also encourage them to walk rather than use transport and to use stairs where possible. Simple home exercise aids such as weights and pulleys, and hot water bottles for heat treatment are discussed.

### CONCLUSION

Out of 66 patients assessed, we found that the spine, hip and shoulder joints were those most frequently affected. The average chest expansion was 2 cm, compared to the average of 6 cm. of 20 normal subjects. In general their walking tolerance was less than normal and I required a walking aid. Only 16 patients were able to squat fully.

On admission, the ankylosing spondylitis patient undergo an intensive exercise program as immobilization will only promote deformities and stiffness. We aim to educate the patient about the nature of the disease, and advise and guide him in his own home management.

# ANKYLOSING SPONDYLITIS: ITS SOCIAL AND ECONOMIC IMPLICATIONS

Rosita L. C. Leung\*  
Patrick W. L. Leung\*  
Eric K. W. Ho\*

\* The Duchess of Kent Children's Hospital at Sandy Bay, Hong Kong.

## INTRODUCTION:

It is known that ankylosing spondylitis is a disease which affects young and middle-aged people (principally young men) in their most productive years. Much has been said and done in the treatment and management of the disease so that its disabling effects are minimised. However, concern with just the measurable physical condition is inadequate. In rehabilitation planning, consideration should be given to the social and economic implications of the disease. Matters such as the amount of psychological support elicited, employability, the availability of occupational retraining facilities, individual's adaptability and the ease of integration into society are variables that should be carefully looked into. Consideration of them led to a study being set up at The Duchess of Kent Children's Hospital at Sandy Bay to collect information on these areas.

## SAMPLE

The sample consisted of 100 randomly-selected ankylosing spondylitis patients regularly followed up at the Out-patients Department of The Duchess of Kent Children's Hospital at Sandy Bay. Altogether they represented about one-third of the total pool of ankylosing spondylitis patients seen at D.K. C.H.

## METHOD

The 100 patients were interviewed and given a questionnaire which was completed by each person individually. The questionnaire was specifically designed for this study and included sections on demographic characteristics, impact of illness on family life, occupational history, housing condition, transport, social participation and leisure activities.

The patients were also rated by the physician in charge of these patients according to the severity of their illness. They were grouped into 3 categories, namely mild, moderate and severe.

The collection of data was conducted from Nov. 1984 to Feb. 1985.

## RESULTS

### Sex and Age

Of the 100 patients seen, the majority were men (93%), giving a sex ratio of 13 to 1 between male and female. This did not represent a biased sample as ankylosing spondylitis was predominantly

found in male. And our results simply confirmed the trend of a male dominance in this disease. Two-thirds (67%) of the sample were aged under 35 and only 8% were over 50 years old. Half (58%) had had onset of their illness before the age of twenty and nearly all felt that the disease started before 30. These results re-confirmed the gravity of the problems in the management of ankylosing spondylitis. The disease, if it was not properly managed, will be affecting the most productive years of a person's life. Besides the physical suffering it imparted, it would also be very demoralizing to the spirit of any person. Particularly, the disease affected predominantly male who would certainly regard those years as the best time in their life in terms of starting a family or building an ambitious career.

### Educational History

Half of the subjects had secondary education and a further 12% had post-secondary education while one-quarter of them had only primary schooling.

### Marital Status

Only one-third of the sample were married, 4% were divorced or separated and the rest were single. Most of the married subjects had children.

### Impact of Illness on Family Life

Generally, our sample found their family to be concerning and supportive. The majority (two-thirds) felt that their families at least had had some knowledge of their illness and were concerned about their condition. Knowledge and concerns were found to be inter-correlated. It was difficult to judge here whether knowledge enhanced concerns to the patients or concerns manifested themselves in seeking of greater knowledge to understand the patients.

In the area of family relationship, it was surprising to learn that about half of the sample indicated the illness to have no significant impact on their family relationship. A further one-quarter even felt that the illness actually contributed positively to the harmony and cohesiveness of the family!

On the other hand, there was one-quarter of the sample who reported adverse effects of the illness on the family relationship. One-quarter was probably too large a number to be ignored.

## Employment

14% of the sample were unemployed, among whom 10% had been persistently unable to gain employment. This unemployment rate was markedly higher than the national norm which was usually at or less than 4%. There was another 5% of the sample who could only obtain part-time employment.

For those who were employed, half of them held blue-collar jobs. Another one-third had white-collar jobs.

Half of the sample earned less than HK\$3,000 per month. A mere 5% had monthly income exceeding HK\$7,000.

Most subjects felt that ankylosing spondylitis had negative effects on their jobs. Half of the sample considered the disease a barrier to career development while a further one-third regarded it as an impossible barrier.

23% of our subjects complained of being unfairly discriminated against and refused employment. In some cases, it was difficult to say whether someone had been refused a job because of ankylosing spondylitis or for other totally unrelated factors. However, there was evidence to suggest that job refusal was much more likely if ankylosing spondylitis or other kinds of disabilities were mentioned either on the application form or at the interview.

The majority of the sample complained that their working condition allowed no flexibility. As ankylosing spondylitis required its sufferers to have alternating periods of rest and work, jobs that gave no such allowance were difficult for the ankylosing spondylitics. Only a minority group of our subjects had the possibility of dividing their working day between sitting and moving around. While people in clerical and other non-manual jobs were more likely to spend much of their day sitting or in one postural position, people in manual occupations had to move around or stand all day. Both situations would cause considerable pain and stiffness to the ankylosing spondylitis patients. Thus, it was regretful, though not unexpected, to learn that one-third of our subjects finally decided to change or give up their jobs owing to the difficulties experienced during work. They generally found their jobs either too physically demanding or too damaging to their physical condition.

Consequently, 20% of our subjects were said to have recently moved to their present jobs (within a year) while only half of the total sample had stayed on their jobs for more than 5 years. So a general tendency to switch jobs and have a poorer job stability history might be a common fact of life among some ankylosing spondylitics.

For those who decided to stay on with their jobs, there were other problems. 15% of our subjects had history of being sacked. 12% had had conflicts with their colleagues. Promotion had also been affected while some opted against another better job because of lack of confidence. They felt either that they could not take any additional responsibility

or that they preferred the security of the jobs they knew.

## HOUSING

Only one-quarter (27%) of our sample had their own flats. Over half of the subjects either rented flats from the Government or the private sector. The remaining lived in rented rooms (5%), wooden huts (5%) or quarters provided by employers (9%). One person lived in a rented bed space.

Most of the subjects lived with their family and relatives with average number of five people under the same roof. Only a very small proportion of the un-married subjects lived alone (6%).

The majority of the sample (73%) stayed in units with areas less than 500 sq.ft.. Only 4% lived in apartments with areas over 1000 sq.ft.. Although these figures did not indicate a particularly congested living condition for spondylitics by Hong Kong standard, limited living space did create a lot of extra difficulties. Because of the stiffness and restricted mobility a spondylitic suffered, more room was preferred to arrange furniture and utensils spaciouly within comfortable reach to avoid too much bending, stooping or stretching. On the other hand, limited space would force the furniture and utensils to be arranged in disorderly manner thus causing unnecessary strain on the spondylitics in reaching for objects of frequent use.

While the majority of the subjects lived on ground or lift-landed floors, one-third of them still had to climb stairs. Although most were relatively unimpeded in walking, many probably experienced a severe test on their physical endurance in negotiating stairs.

In a small place like Hong Kong where everything is naturally within easy reach for everybody. One would not be surprised to learn that the majority of our sample (83%) indicated easy reach to community services such as banks, markets, post-office and public transport in the neighbourhood.

## Transport

Only a small minority of the sample (5%) owned or had ready access to private cars. They were relatively trouble-free in travelling in comparison with other spondylitics.

Most of the subjects had to use public transport. The bus and the minibus were the commonest forms used while underground rail and trams were used occasionally. Problems of varying degrees arose. These included difficulties in mounting the bus steps, jolting and jarring of the spine from the bus movement, lack of leg-room when sitting and the non-cushioned seats of the underground. A small percentage of the subjects (8%) was forced to take taxi, the most expensive form of public transport, in order to avoid discomforts.

## Social Adjustment

The majority of the sample had no particular complaint in doing household chores, managing

activities of daily life and getting along with family, relatives and friends. They were happy with the ways they were. Occasionally, there might be some people who had some specific problems. One person stopped attending social functions to avoid the irritation of being questioned about the illness by relatives and friends. Some were dissatisfied of being left out in important family decisions such as family budgeting.

The most irksome issue that bothered a larger portion of our sample was related with sex. Half of the subjects had never dated the opposite sex nor had any experience of sexual activities. Only a small proportion (5%) had sexual activities regularly. However, sex was a mixed blessing, many spondylitics who had the opportunity of having sexual activities experienced difficulties and preferred to have less of them. This appeared to be a passive and non-constructive means to solve a problem.

### Leisure

Many people felt that ankylosing spondylitis had in some ways restricted their leisure life. Sports activities had to be abandoned for some while others pursued less active hobbies as the disease progressed. By the end of the day, some felt too exhausted to go out or join in with the family. For those who had difficulty in employment, their poor finances did not allow them to participate much in leisure activities.

Thus, it was somewhat expected to learn that two-thirds of the sample spent most of their leisure time watching T.V. or reading newspapers and magazines. Other favoured leisure activities included shopping, movie-going, listening to radio, playing majong, and visiting friends and relatives. So vigorous activities of any type were not on the list. On the other hand, half of the sample recognized the importance of keeping themselves mobile and managed to do some kind of exercises regularly.

Vacations and trips were two activities that generated a certain amount of ambivalence. On one hand, travelling might be uncomfortable but these activities were by nature attractive to many people who wished to increase the frequency of them.

There was a minority of the sample (22%) who indicated to have spent much of their leisure time doing nothing but just remained idle. Although they would have preferred otherwise, there seemed little else that they could do.

There was some correlation between movement restriction caused by ankylosing spondylitis on the one hand and satisfaction level of social and leisure activities on the other. The less mobile spondylitics, therefore, seemed to be more dis-satisfied with their social life and vice versa.

### CONCLUSION

In dealing with various stress and demand of modern life, the spondylitics were able to surmount a number of hurdles while sometimes their disadvantages were too great to be overcome.

On the positive side, the majority of the spondylitics reported little adverse impact of the illness on their family relationship. They were reasonably adjusted socially and adequate in coping with their daily life.

However, a substantial portion of spondylitics (25%) did indicate an adverse effect of the illness on their family relationship while many spondylitics complained of restrictive influence of their illness on their social and leisure activities. The finding that half of our sample had never dated a member of the opposite sex and two-thirds were unmarried gave hint of the possible hindrance of the illness on heterosexual relationship. There could be different possible explanations for this unfortunate state of events. The actual deformities (like a hunched back or awkward gait) caused by the illness might make the spondylitics physically unattractive. On the other hand, the spondylitics might be oversensitive to their minor physical deformities and felt themselves too inferior to approach members of the opposite sex.

The spondylitics were evidently having difficulties in areas of transport, housing and employment. The disadvantage in employment represented a key issue of central importance. It had direct bearing on the economic well-being of the spondylitics. This in turn determined how much resources the spondylitics could have to overcome the problems of transport and housing.

Thus, it appeared that a chronic disease like ankylosing spondylitis has repercussion spread to the social and economic well-being of its sufferers. Besides physical discomfort and deformities, the whole quality of living is being implicated and adversely affected. Rehabilitative medicine must take on the multi-dimensional nature of the disease and strive to tackle the problems of living thus resulted. The finding of this present study point to one inevitable conclusion: social services must be an integral part of the rehabilitative medicine to aid the social and economic disadvantages of the spondylitics.





# THE PSYCHOSOCIAL ADJUSTMENT OF PATIENTS WITH ANKYLOSING SPONDYLITIS

Patrick W. K. Leung,  
*The Duchess of Kent  
Children's Hospital at Sandy Bay*

Peter W. H. Lee,  
*Department of Psychiatry,  
University of Hong Kong*

F. Lieh-Mak,  
*Department of Psychiatry,  
University of Hong Kong*

and

Eric Ho  
*Department of Orthopaedic Surgery,  
University of Hong Kong*

## INTRODUCTION

Ankylosing Spondylitis is a rheumatic disease that affects the joints of the spine. Sometimes, it also involves joints in the hip, knee or ankle. The symptoms are restriction or stiffness in the movement of the affected joints as well as pain. The severity of the condition ranges from immobility to relatively free movement with minor discomforts. Currently, there is no effective "cure" for the disease in forms of completely eliminating the pathogenic agents or reverting the pathological process. For the patients, however, this situation is hardly satisfactory. The age of onset of the illness can be as early as adolescence. Thus, the most productive period of a person's life is affected as he faces a life-long incurable illness for the many years to come (Calabro<sup>1</sup>). As the disease is also known to deteriorate despite the best of medical and paramedical care, the uncertainty surrounding its prognosis is unsettling. Most patients complain about the periodicity of the disease as abrupt changes of physical conditions may occur from day to day or week to week (Bird<sup>2</sup>). Besides the actual discomfort, the unpredictability and uncontrollability of the disease demand constant re-adjustment in patients and their families. Since the change is invisible and may be abrupt, it is difficult for the patients not to feel a fraud at times (Chamberlain<sup>3</sup>). Very often, even the closest relatives and peers may fail to appreciate the gravity of the patients' suffering.

The relationship between unpredictability and uncontrollability on one hand and mental ill health on the other hand has attracted a lot of attention. Mineka and Killstrom<sup>4</sup>, in re-analyzing the studies on experimental neurosis, postulated that unpredictability and uncontrollability are the key ingredients that lead to cognitive, affective and somatic disturbances. Antonovsky<sup>5</sup> advocated a sense of coherence as positively related to a person's overall health status. Coherence was defined as "a pervasive, enduring though dynamic feeling of confidence that one's internal and external environments are

predictable and that there is a high probability that things will work out as well as can reasonably be expected" (Antonovsky<sup>5</sup>). Rotter's<sup>6</sup> concept of locus of control is another theoretical position which is useful in explaining adjustment to life changes. A person with an internal locus of control sees himself as controlling his life while a person with an external locus of control has an opposite view of himself. Lee et al<sup>7,8</sup> were able to demonstrate that locus of control is predictive of the psychosocial adjustment of physically disabled children and adults with hand injuries.

Coates<sup>9</sup> advocated cultivating a kind of emotional stability to help patients keep their disease at bay. The emotional stability involved "a determination to press on and to get on with things, work and daily living, regardless" (Coates<sup>9</sup>). This is indeed highly desirable in the management of ankylosing spondylitis as active patient participation is required. In line with this, Rogers<sup>10</sup> advocated an active daily regime of physical exercises as being beneficial to patients.

Depressive features were noted to be common in ankylosing spondylitis patients. Common signs are fatigue, loss of interest or pleasure in usual activities, psychomotor retardation or mental indecisiveness. Such characteristics run contrary to the demand for active daily exercises. A person with depressive tendency is unlikely to be able to do so. The presence or absence of psychological disturbance such as depression among ankylosing spondylitis patients is of utmost significance in affecting its course and resultant disability. Furthermore, depression in itself is a clinical entity that brings suffering to the patients and their families. Surveys on the prevalence of psychological disturbance among ankylosing spondylitis patients are however curiously and seriously missing.

Buchanan<sup>11</sup> after surveying 150 ankylosing spondylitis patients, concluded that "a few people suffer from depression; but on the whole the patients

interviewed were able to cope adequately with social problems". This appears a rather optimistic note and is at odds with what was observed locally. Regretably, she did not provide any exact percentage or other statistical figures.

It will be insufficient to only take note of the psychological repercussion of ankylosing spondylitis. The personal, economic and social disadvantages arising from the disease also require investigation. Rehabilitation of ankylosing spondylitis patients can hardly be completed without concrete plans and services for combating such disadvantages.

In England, surveys by Chamberlain<sup>12</sup> and Buchanan<sup>11</sup> reported that ankylosing spondylitis patients presented with numerous problems involving personal, economic and social disadvantages which were not superficially apparent. Lau<sup>13</sup> reporting on a small sample of 28 ankylosing spondylitis patients in Hong Kong, indicated that they faced problems in areas of employment, marriage, housing and finance.

The present study is aimed at examining three interrelated questions in connection to the psychosocial adjustment of ankylosing spondylitis patients:

- 1) the prevalence of psychological disturbance among ankylosing spondylitis patients,
- 2) the types and the amount of personal, social and economic problems reported by the patients,
- 3) the pattern of inter-relationship between the three key factors involved in this study: the severity of the disease itself, the magnitude of the psychological disturbance, and the amount of personal, economic and social problems.

## METHOD

### Subjects

A random sample of 101 patients was selected from the Ankylosing Spondylitis Clinic of The Duchess of Kent Children's Hospital at Sandy Bay. There were 92 males and 9 females with a mean age of 32 years ranging from 16 to 60 years old.

### Procedure

Each subject was interviewed individually to facilitate the establishment of rapport and optimal motivation to participate in the research project. They were chosen at random and approached personally while waiting to see their doctor. The interview took about 20 to 30 minutes.

### Assessment performed

The Goldberg's<sup>14</sup> 12-item short-form General Health Questionnaire (GHQ) was used. Lee et al<sup>15</sup> reported their experience in the use of the Questionnaire in Hong Kong. They recommended some modifications for local usage. The original format of GHQ, requiring comparison of the present with 'what was usual', was found to be difficult to comprehend, even after repeated explanation. Instead, the frequency of occurrence ie., 'never',

'seldom', 'sometimes', and 'usually' was found to be clearer and easier to understand. Furthermore, a Likert-type scoring was found to be more valid and discriminating than the original GHQ scoring. These suggestions were incorporated into the administration and scoring of GHQ in our present study.

The second measure administered was a 54-item short-form of the Mooney Problem Check List - Adult Form (MPCL) adapted from the original 288 items (Gordon and Mooney<sup>16</sup>). The current short-form covers possible problem areas relating to 'economic security', 'self-improvement', 'personality', 'home and family', 'courtship', 'sex', and 'occupation'. The administration of MPCL involves a two-level intensity response to the items (i.e. designation of "troubling" problems, and "most concerned" problems) and generates two separate scores (M1 & M2) for each subject by adding up the number of problems reported.

A rating of the severity of the subject's disease condition on a three-point scale was also obtained from the orthopaedic surgeon in charge of the Ankylosing Spondylitis Clinic. The rating is based on the intensity of reported pain and a measure of stiffness of affected joints.

## RESULTS

### The Prevalence of Psychological Disturbance

Adopting the cut-off point of 14/15 through direct extrapolation from the original long-form GHQ (Lee<sup>15</sup>), 40.6% of our patients were considered to be suffering from neurotic but non-psychotic disorders of varying degrees.

### Personal, Economic and Social Problems reported

Table 1 lists all the items in the MPCL which were reported by 25% or more of our subjects to be "troubling" (Level-one response).

**Table 1: Items in the MPCL indicated as "Troubling" (Level-One Response) by 25% or more of the Subjects:**

Item Description	Percentage of Subjects Reporting	Areas
45) Worried about security in old age	46.5%	Economic security
12) Fearing future unemployment	45.5%	Economic security
13) Not being as efficient as I would like	40.5%	Self-improvement
3) Lacking skill in sports and games	37.6%	Self-improvement
29) Needing more outdoor air and sunshine	35.6%	Self-improvement
9) Disliking financial dependence on others	31.6%	Economic security
22) Wanting to improve my appearance	31.6%	Self-improvement
31) Feeling I am too different	29.7%	Personal

1) Transportation or commuting problem	26.7%	Economic security
30) Wishing I had a better educational background	25.7%	Self-improvement
46) Not having enough social life	25.7%	Self-improvement

Table 2 present items in MPCL which were "of most concern" to our subjects (Level-two response). Only those reported by 10% or more of our subjects are listed here.

**Table 2: List of Items in the MPCL indicated as "of most concern" (Level-Two Response) by 10% or more of the Subjects**

Item Description	Percentage of Subjects Reporting	Areas
45) Worried about security in old age	19.8%	Economic security
12) Fearing future unemployment	18.8%	Economic security
8) Needing a job	13.8%	Economic security
13) Not being as efficient as I would like	12.8%	Self-improvement
3) Lacking skill in sports and games	10.8%	Self-improvement
31) Feeling I am too different	10.8%	personal

There were 6 items, denoted as "most concern" by 10% or more of the subjects. These items were also related to financial worries and personal incapacity. On the whole, the ankylosing spondylitis patients appear to report relatively less problems in other areas such as sex, courtship, family and home.

#### Relationship between the Severity of the Disease, Psychological Adjustment and Personal, Economic and Social Problems

Table 3 presents a correlation matrix involving the three key factors in this study: the severity of the disease (S), the magnitude of psychological disturbance (GHQ), and the amount of personal, economic and social problems (M1 & M2 of MPCL).

**Table 3: Correlation Matrix involving Measures of Severity, GHQ, and Mooney Problem (M1 & M2)**

#### Variables:

1) S	1.000			
2) M1	0.125	1.000		
3) M2	0.004	0.797*	1.000	
4) GHQ	0.107	0.552*	0.462*	1.000
	1) S	2) M1	3) M2	4) GHQ

\*significant at the 0.01 level

#### KEY:

S: Severity of physical condition ratings  
GHQ: General Health Questionnaire measure

M1: Items in the Mooney Problem Checklist indicated as "troubling"

M2: Items in the Mooney Problem Checklist indicated as "of most concern"

The severity of the disease had little correlation with the magnitude of psychological disturbance (GHQ) as well as with the amount of personal, economic and social problems (M1 & M2). Psychological disturbance correlated moderately with the frequency of reported personal, economic and social problems. Patients manifesting more symptoms of neurotic disorders also indicated more personal, economic and social problems. A high correlation was noted between M1 and M2 of the MPCL, being both indicators of the amount of problems faced by the subjects.

#### DISCUSSION

The significance of a 40.6% prevalence rate of possible psychoneurotic problems in our patients is self-evident when this is compared with data from other population surveys involving non-patient adults. Table 4 shows the results of relevant studies with their estimates of the prevalence of neurotic disorders.

**Table 4: Comparison of Estimates of Neurotic Disorders in different Studies**

Authors	Populations	Country	Estimates	Measure
1) Leung et al (1985)	Ankylosing Spondylitis Patients (adult)	H.K.	40.6%	GHQ
2) Lam et al (1985)	Non-patient (adult)	H.K.	31.9%	GHQ
3) Lee (1980)	Non-patient (adult)	H.K.	31.6%	Langner's scale
4) Langner (1962)	Non-patient (adult)	U.S.A.	31.2%	Langner's scale

Population surveys with non-patient subjects<sup>17,18,19</sup> reported almost identical results. This confirms the view of Goldberg and Huxley<sup>20</sup> who noted a consistency for the rate of neurotic disorders in recent studies using different instrument. Such consistent results further underscore the significance of a roughly 10% difference between the estimates for ankylosing spondylitis patients and for non-patient populations.

It is worth noting that the items in MPCL most frequently indicated as "troubling" (Level-one response) were also indicated as "of most concern" (Level-two response). 5 of the top 6 items in Table Two also appear among the top 8 items in Table One. This double-reportings highlight the importance of those worrisome areas reported.

Worries about the future is apparently very much in the minds of many ankylosing spondylitis patients.

This is borne out by the finding that the top 2 items from both Level-one and Level-two responses, were identical and both described anxiety in future livelihood and employment. In certain ways, these are realistic worries in view of the incurable nature of the disease and its unpredictable course. Varying amounts of pessimism seem natural and evident in the minds of many patients.

This aspect of worry for the future received little attention in the literature on ankylosing spondylitis<sup>3,11,12,21</sup>. Either the design of these studies has left no avenue to unveil such concern or the patients in other countries may be sufficiently assured by the adequate provision of social services. Whatever the reasons may be, the implication of our present finding is clear. Any service provision to ankylosing spondylitis patients in Hong Kong must be planned with a long-range perspective. Focus on the immediate present can hardly be sufficient or reassuring. Such long-range planning is vital in fostering a sense of predictability and controllability as well as reducing the anxiety of uncertainty. This requirement puts enormous demand on the foresight and imagination of the service provision planners.

Other items in MPCL reported with the most frequencies cut across a wide spectrum of concerns, frustrations and needs. All of them tended to be concrete and real-life problems, many of which have been discussed in other studies. There are however, common themes linking these diverse concerns. A sense of inferiority and inadequacy permeates these statements as items 13 (not as efficient), 3 (lacking skill), 22 (improve appearance), 31 (too different), 30 (wish a better education), and 9 (financial dependence). In fact some patients reported that they were often stopped by police in the streets because of their sloppy appearances and were often mistaken to be drug addicts. Loneliness is implied with such statements as item 46 (not enough social life). Life becomes confined and restrictive as the patients report in item 29 (need more outdoor air and sunshine) in combination with item 1 (transport problem). Opportunities for meaningful occupation and leisure-time activities after thus restricted.

A number of studies have demonstrated the effects of the above mentioned variables on mental health. Particularly noteworthy contributions are by Adler<sup>22</sup> on inferiority complex and by Coopersmith<sup>23</sup> on self-esteem. The DSM-3<sup>24</sup> alerts the clinicians about the significant influence of social company, meaningful occupation and leisure-time activities on psychological adjustment. For the mental health workers, ankylosing spondylitis presents a battlefield of many fronts, spreading across the interrelated domains of neurotic tendency, personality inadequacy, social handicap, and economic disadvantage. A combination of well-coordinated psychiatric, psychological and social services is imperative in alleviating the manifold problems associated with ankylosing spondylitis.

It is rather unexpected that ankylosing spondylitis patients reported relatively fewer problems in the areas of sex and courtship. Chamberlain<sup>3</sup> noted that 36% of the male patients and 67% of the female patients had their sexual activity adversely affected by the disease. One plausible explanation for the absence of similar results in our study is the difficulty of eliciting such rather sensitive or taboo material with a highly structured paper-and-pencil measure. In fact, Chamberlain also admitted difficulties with interview techniques.

The responses of some patients toward discussion of difficult problems are interesting. Very often, discussion of difficult problems were actively rejected. When pressed, they would admit that any such reckoning will only bring along side-effects such as insomnia, headache, and a depressed mood, while nothing of value will result from the discussion. This appears to be a coping strategy to ward off disturbing thoughts and their concurrent depression and psychosomatic symptoms. Problems in sex and courtship, important yet taboo topics in Chinese culture, are possibly too sensitive to be mentioned and faced. Instead, the patients attempted to cope by actively suppressing the thought of such problems. Further studies should be done on the role of denial as a coping strategy as well as its potential harm and benefit.

There has been some controversy concerning the relationship between the degree of severity of a physical condition and the extent of mental ill health. The results reported are often conflicting, with some studies reporting a "no relationship" (Lee et al<sup>8</sup>), and some a "significant relationship". ( Tsoi et al<sup>26</sup> ) Our results demonstrated little correlation between severity on one hand and GHQ and M1 & M2 on the other hand. However, McDaniel<sup>25</sup> after reviewing extensively studies of both positions, gave a personal opinion supporting the "significant relationship" position.

The lack of consistency among the various studies is due to the presence of intervening variables. The degree of disability, in combination with a host of other variables such as age, sex, personality, attitude, family dynamics, cultural setting, social service system, and many others, collectively shape and chart the course of a person's psychological development.

The significance of our findings does not lie on its verification of either the "no relationship" or "significant relationship" positions. The futility of attempting to establish such a simplistic relationship is self-evident. Rather, our current findings suggest the existence of a number of other intervening variables besides the severity of the disease in mediating mental ill health. As ankylosing spondylitis is by and large incurable, it might be a relief to learn that the severity of the condition does not have an overriding impact on mental health. This situation

gives hope to the mental health professionals that there may be more room for manoeuvre. The possibility exists that some of the other intervening variables involved may be more amenable to change than the physical condition of the patients.

This study has certain limitations. It is a cross-sectional and descriptive study that was primarily intended to survey the mental health status of the patients involved. The design of the project stops short of further investigation into the pertinent intervening variables as discussed above. A further analysis of these factors will be the next logical step.

A second limitation of the current study is the failure to address the question of the impact of psychological disturbance on the course of ankylosing spondylitis. This will require a longitudinal research design rather than the current cross-sectional one.

## REFERENCES

1. Calabro, J.J. & Mody, M.E. (1965): *Management of Ankylosing Spondylitis*. *American Journal of Occupational Therapy*, 19, 255.
2. Bird, H. (1982): *Ankylosing spondylitis measuring activity of disease*. In *National Ankylosing Spondylitis Society (ed.), The National Ankylosing Spondylitis Society Symposium 1981*. Bristol: Burleigh Press.
3. Chamberlain, M.A. (1980): *Socio-economic and psychological factors in management*. In J.M.H. Moll (ed.) *Ankylosing Spondylitis*. Edinburgh: Churchill Livingstone.
4. Mineka, S. & Killstrom, J.F. (1978): *Unpredictable and uncontrollable events: a new perspective on experimental neurosis*. *Journal of Abnormal Psychology*, 87, 2, pp. 256-271.
5. Antonovsky, A. (1979): *Health, stress, and coping*. San Francisco: JosseyBass Publishers.
6. Rotter, J. B. (1966): *Generalized expectancies for internal versus external control of reinforcement*. *Psychological Monograph*, 80 (1, whole no. 609).
7. Lee, P.W.H., Lieh-Mak, F (1984): *Locus of control, teachers' rating and task performance of physically handicapped children*. In *The Exceptional Child*, Vol. 3, No. 2 (July), pp. 128-133.
8. Lee, P.W.H., Ho, E.S.Y., Tsang, A.K.T., Cheng, Y.H., Cheng, J., Leung, P.C. & LiehMak, F. (1985): *Psychological adjustments of victims of occupational hand injuries*. In press.
9. Coates, J. (1982): *Overcoming spondylitic disability*. In *National Ankylosing Spondylitis Society (ed.), The National Ankylosing Spondylitis Society Symposium 1981*. Bristol: Burleigh Press.
10. Rogers, F. (1983): *Helping patients to live with Ankylosing Spondylitis*. *The Practitioner*, 227, pp. 1187-1189.
11. Buchanan, J. (1982): *The social and economical disadvantages of ankylosing spondylitis*. In *National Ankylosing Spondylitis Society (ed.), The National Ankylosing Spondylitis Society Symposium 1981*. Bristol: Burleigh Press.
12. Chamberlain, M.A. (1981): *Socio-economic effects of Ankylosing Spondylitis*. *International Rehabilitation Medicine*, 3, 2, pp. 94-99.
13. Lau, M. (1983): *A brief social report on patients with ankylosing spondylitis*. Unpublished manuscript. The Duchess of Kent Children's Hospital at Sandy Bay, Hong Kong.
14. Goldberg, D.P. (1972): *The detection of psychiatric illness by questionnaire*. London: Oxford University Press.
15. Lee, P.W.H., T.H. Lam, S.G. Ong, C.M. Wong, J.W.L. Kleevens (1984): *Experience in using Goldberg's General Health Questionnaire in studying mental health in the work setting in Hong Kong*. Paper presented in symposium on Cross-Cultural Psychiatric Epidemiology, Hong Kong.
16. Gordon, L.V. & Mooney, R.L. (1950): *The Mooney Problem Check Lists*. New York: The Psychological Corporation.
17. Lam, T.H., Ong, S.G., Wong, C.M., Lee, P.W.H., & Kleevens, J.W.L. (1985): *Mental health and work stress in office workers in Hong Kong*. In press.
18. Lee, R.P.L. (1980): *Sex roles, social status, and psychiatric symptoms in urban Hong Kong*. In A. Kleinman & T.Y. Lin (eds.) *Normal and abnormal behaviour in Chinese culture*. U.S.: D. Reidel Pub. Co.
19. Langer, T.S. (1962): *A twenty-two item screening score of psychiatric symptoms indicating impairment*. *Journal of Health & Social Behaviour*, 3 (winter), pp. 269-276.
20. Goldberg, D.P. & Hurley, P. (1980): *Mental illness in the community: the pathway to psychiatric care*. London: Tavistock.
21. Peer, K.M. (1985): *Living with ankylosing spondylitis*. Bristol: Burleigh Press.
22. Adler, A. (1927): *The practice and theory of individual psychology*. New York: Harcourt Brace.
23. Coopersmith, S. (1967): *The Antecedents of Self-esteem*. W.H. Freeman & Co.

This aspect of study has become more pressing and valuable in view of a high prevalence of psychological disturbance among the ankylosing spondylitis patients.

## CONCLUSION

A first step has been taken to examine the psychosocial adjustment of the ankylosing spondylitis patients. They have a higher rate of neurotic disorders and face a host of personal, economic and social problems. The finding that the severity of the disease does not have an overriding impact on the patients' mental condition suggests the presence of other intervening variables worthy of further study.

24. American Psychiatric Association (1980): *Diagnostic and statistical manual of mental disorders*, 3rd ed.  
 25. McDaniel, J.W. (1976): *Physical disability and human behaviour* (2nd ed.). New York: Pergamon Press.  
 26. Tsoi, M.M., Leung, P.W.L. & Chow, S.P. (1982): *Psychological reactions to hand injuries among semiskilled Chinese workers. Annals Academy of Medicine*, 11, 2, pp. 214-217 .

## APPENDIX A

Subjects' responses to all the 54 items in the MPCL:

Item Description	% of Ss with Level-one Response	% of Ss with Level-two Response	Areas
1. Transportation or commuting problem	26.7%	6.9%	Economic security
2. Poor living conditions	14.8%	5.9%	Economic security
3. Lacking skill in sports or games	37.6%	10.8%	Self-improvement
4. Not knowing how to entertain	14.8%	0.9%	Self-improvement
5. Worried about a member of my family	21.7%	4.9%	Home & family
6. Not finding a suitable life partner	19.8%	5.9%	Courtship
7. Being financially unable to get married	15.8%	4.9%	Courtship
8. Needing a job	21.7%	13.8%	Economic security
9. Disliking financial dependence on others	31.6%	4.9%	Economic security
10. Having too many financial dependents	7.9%	0.9%	Economic security
11. Getting into debt	8.9%	2.9%	Economic security
12. Fearing future unemployment	45.5%	18.8%	Economic security
13. Not being as efficient as I would like	40.5%	12.8%	Self-improvement
14. Not using my leisure time well	15.8%	1.9%	Self-improvement
15. Too few opportunities for meeting people	20.7%	3.9%	Self-improvement
16. Trouble keeping up a conversation	12.8%	2.9%	Self-improvement
17. Not mixing well with the opposite sex	10.8%	2.9%	Self-improvement
18. Irritated by habits of a member of my family	11.8%	2.9%	Home & family
19. Too much quarreling at home	12.8%	6.9%	Home & family
20. Not really having a home	11.8%	5.9%	Home & family
21. Afraid of the responsibilities of marriage	17.8%	1.9%	Courtship
22. Wanting to improve my appearance	30.6%	6.9%	Self-improvement
23. Being left out of things	13.8%	3.9%	Personal
24. Not being understood by my family	18.8%	2.9%	Home & family
25. Feeling rejected by my family	6.9%	2.9%	Home & family
26. Afraid of losing the one I love	5.9%	0.9%	Courtship
27. Too little money for recreation	16.8%	5.9%	Economic security
28. No steady income	21.7%	6.9%	Economic security
29. Needing more outdoor air and sunshine	35.6%	4.9%	Self-improvement
30. Wishing I had a better educational background	25.7%	5.9%	Self-improvement

Item Description	% of Ss with Level-one Response	% of Ss with Level-two Response	Areas
31. Feeling I am too different	29.7%	10.8%	Personal
32. People finding fault with me	7.9%	0.0%	Personal
33. Feeling no one cares for me	16.8%	3.9%	Personal
34. Not getting along with a member of my family	10.8%	3.9%	Home & family
35. Thinking too much about the opposite sex	2.9%	0.0%	Sex
36. Repelled by thoughts of sexual relations	0.0%	0.0%	Sex
37. Needing information about sex	3.9%	2.9%	Sex
38. Lacking necessary experience for a job	10.8%	3.9%	Occupation
39. Living far beyond my means	15.8%	4.9%	Economic security
40. Parents separated or divorced	2.9%	0.0%	Home & family
41. Parents sacrificing too much for me	9.9%	0.9%	Home & family
42. Lacking sex appeal	11.8%	1.9%	Sex
43. Finding my work too routine or monotonous	23.7%	0.9%	Occupation
44. Would rather be doing other kind of work	7.9%	0.9%	Occupation
45. Worried about security in old age	46.5%	19.8%	Economic security
46. Not having enough social life	25.7%	3.9%	Self-improvement
47. Being alone too much	21.7%	3.9%	Self-improvement
48. Missing my former social life	20.7%	0.0%	Self-improvement
49. Worry whether my marriage will succeed	14.8%	2.9%	Home & family
50. Having different interests from husband or wife	3.9%	0.0%	Home & family
51. Sexual needs unsatisfied	7.9%	0.0%	Sex
52. Not liking some of the people I work with	3.9%	0.0%	Occupation
53. Afraid of losing my job	19.8%	8.9%	Occupation
54. Wanting to develop a hobby	14.8%	0.0%	Self-improvement

**KEY:**

LEVEL-ONE RESPONSE: Indicate as “troubling”

LEVEL-TWO RESPONSE: Indicate as “of most concern”





A STUDY OF PAIN IN PATIENTS SUFFERING  
FROM  
ANKYLOSING SPONDYLITIS

*by* Mrs. Hsu Yam Li Li, Christine , B. So. Sc.

*Supervisor:* Dr. J. A. Spinks , Ph.D.,  
Senior Lecturer in Psychology, H.K.U.  
President, HK Psychology Society

## ACKNOWLEDGEMENT

The author wishes to express deep gratitude and appreciation to Dr. J. A. Spinks for his patience and guidance.

I am indebted to Mr. E. Kvan for his suggestion to conduct a preliminary interview and to my husband, Dr. Louis C. S. Hsu for his suggestion of the patient group.

Special thanks must go to Dr. Eric Ho and his patients without whom this research would not be possible.

Last but not least, I would like to thank Mrs. Miranda Wong for the amount of time spent in typing this thesis.

This has been a most enriching and rewarding experience which will be treasured forever.

## **ABSTRACT**

Ankylosing Spondylitis is a rheumatic disease that affects mainly the spine and causes stiffness. Since July 1982, a multidisciplinary project has been conducted at Duchess of Kent Children's Hospital. Besides organic aspects, there are also psychological aspects involved and pain is the most important one. The present research concentrates on the nature of pain and its results, the methods for alleviating pain and the measurement of pain intensity. The methodology includes interview, questionnaire, longitudinal study of pain levels, including different ways of measuring pain. Results showed evidence for sudden flare-ups and affective components. Pain, to a certain degree affected jobs, leisure, sex, marriage and daily activities. There was indication of drug reliance and drug abuse. The different measurement methods yielded different results. The result from this research gives considerable amount of background information about the disease, the pain and psychological aspects. A number of recommendations were made concerning measurement of pain, patient management and organization of existing self-help club.

## CONTENT

Chapter 1	Introduction Patient group
Chapter 2	Definition of Pain, its complexity and theories Psychosocial influences Pain management
Chapter 3	Preliminary interview
Chapter 4	1st part of research – Questionnaire
Chapter 5	Results on questionnaires
Chapter 6	Discussion on questionnaires
Chapter 7	2nd part of research – 3 week longitudinal study of diurnal variation of pain Results and discussion
Chapter 8	3rd part of research – measurement of pain intensity by different methods
Chapter 9	Results and discussion of methods
Chapter 10	Conclusion
	References
	Appendix

# 1 INTRODUCTION

Since July 1982, a study on Ankylosing Spondylitis (AS) in Hong Kong Chinese, has been conducted at Duchess of Kent Children's Hospital. Some of the Hong Kong Orthopaedic doctors believed that AS is a rheumatoid condition which had been fairly neglected and unsuccessfully treated. This was due to a lack of realization that the management of this disease should be multifaceted. A report on Ankylosing Spondylitis study in Duchess of Kent Children's Hospital July 82 – June 83 stated as follow: "The problems arising from the disease fall into the territory of the rheumatologists, orthopaedic surgeons, physiotherapists, occupational therapists, laboratory researchers and the medical social workers". They aimed at a unified team approach in management which could provide proper recording of the relevant information of the disease and finally to enable patients to exchange feelings and ideas and discuss problems that they encountered. A self-help group in the name of "Ankylosing Spondylitis PHAB Club" had just been formed in October, 1983.

As yet there is no involvement of psychologists in this ream. Pain is basically one of the major complaints of the AS patients and pain is comprised of both physiological as well as psychological variables. This strongly suggests that the pain aspect of this disease deserves considerable study and investigation.

There are a number of important issues to be looked at in this research. For example, it is of interest and importance to find out how this disease has affected their lives and how they themselves perceive pain. Then the various methods of measuring pain intensity would be reviewed and if possible, compared. Furthermore, from the result of this investigation, maybe some suggestions could be made to the doctors. As Griffiths (1981) has emphasized about the point made by Colette Ray in her article on Pain: "that the doctor's behaviour can be important determinant of the patient's experience of pain or pain behaviour". So it would be advantageous for the doctor to be aware of the influence his behaviour can have on the patient's report and in order to do so, an understanding of the psychological and social factors besides the organic ones will be beneficial.

In the remainder of this chapter, a general description of AS and the resulting physical deformity will be presented. Then the next chapter will deal with the definition and explanation of pain. The subsequent chapters will be devoted to description of methodology and discussion of results from this study.

## Patient group

About 100 patients (referred by various hospitals and clinics) have been centralised. They are suffering from various degrees of severity of AS.

What is common and central to all of them is that they have and/or are experiencing pain in different intensity. The patients are all Chinese and come from different social-economic classes. Out of the 63 patients that participated in this study, only 4 were female.

## Ankylosing Spondylitis

Ankylosing Spondylitis is a rheumatic disease that affects mainly the spine and may lead to significant stiffness of the back. Patients suffering from AS usually suffer severe chronic pain due to inflammation in the joints and as healing takes place, bone grows out from both sides of the vertebra, fuses, producing stiffness. During the process of stiffening, movement precipitates more pain. AS first manifests itself in young and middle-aged people (principally young men) (Calabro 1965). The etiology is not yet known. A new test (HLA B27 antigen) is now being used and a positive result shows that the person has a tendency to spondylitis. Although all sufferers from AS will have this particular blood group antigen, the reverse is not necessarily true. There is a slight hereditary factor involved but the chance of the offspring inheriting the disease is quite low, not more than 1 in 50 (The Handbook of Arthritis & Rheumatism Council, London).

AS takes a different course in different people, and no two cases are exactly the same. The symptoms may come and go over long periods, but in the end AS always burns out spontaneously. The pain will disappear completely but the stiffness will remain permanently. It is impossible to know how long it could take for this to occur and how deformed the patient will eventually become.

At the start, spondylitis usually causes low backache and stiffness. An ache may be felt in the buttocks and possibly down the back of the thighs and in the lower part of the back. These symptoms may be first noticed after some exertion or strain. Aches and pains elsewhere may follow in the neck, shoulders and hips or in the thigh like sciatica. Some people may never have anything more than a series of mild aches and pains, coming and going over a period of months, never troubling them greatly. Others pass through a phase of active spondylitis when symptoms are more troublesome. They become generally unwell, lose weight and tire easily. AS in its early stages may cause considerable pain. Although after hospitalization and the discovery of effective treatment, the pain may be relieved to a certain extent yet the discomfort is not always abolished. Later the disease becomes much less active, or even inactive. During the very active period, hospitalization may be necessary and analgesic tablets or suppositories may be prescribed to relieve pain and inflammation. However, surgery is only needed in straightening the

back or neck in those who have become severely bent.

Since there is yet no real cure for AS, then "the psychological and rehabilitative needs of the patient deserve the most careful thought" (Calabro, 1965). In order to help the AS patients, the physicians should understand the interference caused by the disease. This may affect the patient's diurnal and nocturnal activities. Buchanan and Chamberlain (1978) reported that many AS patients had to pursue less active hobbies as the disease progressed. Their social life was affected due to easy exhaustion after doing unsuitable jobs which for example required much walking or lifting. Another reason could be due to poor finances. Chamberlain (1979) maintained that sexual activity had been adversely affected by the disease. Generalised pain, localised pain and diminished libido took their toll. These problems in the sexual field were due to mechanical problems, drugs and deformity, Buchanan (1981) stated that many AS sufferers feel discriminated against in employment. Information on the patients' needs and what the best treatment is for them is scanty. Chamberlain (1979), in a paper entitled "Socio-domestic and psychological factors in management" stated that not many studies on AS have been done and the few quoted were longitudinal ones. (e.g. Robinson and Walters 1957, Wynn Parry 1966 and Harris 1969). These focused on the rehabilitative aspects of these patients. In Hong Kong, no similar studies have been conducted and the one started at Duchess of Kent Children's Hospital is the only one of its kind.

## 2 DEFINITION OF PAIN

Although pain is an extremely common patient complaint, it is also one of the least understood symptoms in medicine (Bakal, 1979). Some of the complexity of understanding pain phenomena can be seen in attempts at its definition. Sternbach (1968) for example, defined pain as an abstract concept that refers to:

1. a personal, private sensation of hurt;
2. a harmful stimulus which signals current or impending tissue damage;
3. a pattern of responses which operate to protect the organism from harm."

However, these seemed more like descriptions of pain rather than definitions.

The International Association for the Study of Pain (IASP) defined pain in 1979 as "an unpleasant sensory and emotional experience associated with actual or potential tissue damage, or described in terms of such damage (cf. Prokop, 1981).

Ray (1980) defined pain as an unpleasant sensation which is focussed upon the body, and is

often but not always associated with tissue damage. (Griffiths, 1981)

From these definitions, there is clearly indication that besides organic causes, other variables like psychological ones are involved. Although these definitions are satisfactory to all investigators and practitioners, they convey the multidimensional and subjective nature of pain of various etiologies.

Norton (1982) stated the problem of definition. According to him, pain is a subjective experience and there are significant individual differences. Secondly, the vocabulary for pain events is not elaborate, reflecting the ultimately internal nature of pain phenomena and our adaptive efforts to avoid painful experience. Thirdly, reactions to pain may be radically altered by the symbolic meaning of the event. This can be illustrated by Beecher's study in 1956 on wounded soldiers. Of 215 men seriously wounded in battle, only 25% wanted narcotic for pain relief. In comparison, civilians with similar surgical wound made under anaesthesia, over 80% wanted relief. The difference was due to the significance of the wound. In battle, the wound meant a ticket to safety, while in civilian life surgery meant disaster. Another example is childbirth. Uddenberg (1979) maintained that neither amount of bleeding, labour time nor the weight, head circumference and presentation of the foetus had been found to be associated with how women describe their delivery. Hence no correlation was found between obstetric measures of magnitude and women's self-reports about how painful labour had been.

## THE COMPLEXITY OF PAIN

Different stimuli can give rise to pain: pressure, electricity, temperature and chemical substances. Sometimes pain results from no obvious physical damage e.g. phantom limb pain after amputation, and other times there may be true organic causes. The same stimuli that elicit pain can also elicit different responses such as hot or cold, tingling or itchiness, fleeting or long lasting pain. The responses can be very subjective. Melzack (1973) studied individuals with congenital insensitivity and reported that they translate potentially painful stimuli as eliciting sensations of "itching", "tingling", or "tickling" rather than as pain (cf. Kalal, 1979).

The sites from which pain can be elicited are neither universal nor homogeneous. "The skin and cornea are sensitive to pain stimuli; the viscera are less responsive and vary among themselves; the central nervous system is largely insensitive to pain stimuli" (Norton, 1982).

## ACTUE PAIN

Everyone experiences pain every now and then, and usually it is acute. This is short-lasting, or easily reversible. In these instances the pain is a response to tissue damage, actual or impending, e.g. toothache,

stomachache or headache. They serve as a warning signal which cause individuals to take appropriate actions, like seeing a doctor or withdrawing a limb! Sometimes if the pain does not come on too quickly some twinges or uncomfortable feelings may be noticed. People may push it out of awareness as they go on about their activities. It is only when sensations have become more intense and crossed the threshold to become mild pain, are people forced to focus on the pain. When pain is felt there comes mild anxiety or alarm for something may be wrong. A cognitive structure on this experience has to be imposed in order to understand it. When understanding is reached then the initial anxiety dissipates. If, however, the pain persists and increases in intensity, more alarm is felt for the situation may have been misunderstood and it can be more serious than anticipated. The reaction to acute pain situation shows that as pain increases so does anxiety, until, at a certain point, something needs to be done to obtain relief before the pain becomes very severe (Sternberg, 1974).

### CHRONIC PAIN

When the pain persists and intensifies than it is termed chronic. It has changed both in quantity as well as in quality. Sternback (1978) defined chronic pain as "pain of at least several months' duration".

The experience with chronic pain is quite different from acute one. The pain which persists causes the defensive reflexes to diminish because they do not help. The sufferer then tend to seek help more urgently, more desperately and yet the help-seeking behaviour becomes more routinized and hopeless. The patient group that serve as subjects in this study is an example of chronic pain sufferers. Patients with Ankylosing Spondylitis usually experience constant pain, which may wax and wane in intensity but seldom disappears completely until maybe after the disease has settled down.

Chronic pain patients in general cannot give meaning to the pain. They may "understand" it in the sense that he has been given an explanation by his doctor, but the pain is no more a warning signal as it can neither be avoided nor treated. Besides, there is difficulty in finding a purpose for it. The patients may feel bitter and despair at the seeming endlessness of the suffering. The end results may be disturbance of sleep, appetite, and libido (Sternberg, 1974, 1978). Hence, very often antidepressant medication has to be used. (Spear, 1967, Tabu, 1975).

Brena (1978) has expanded upon the phenomena of chronic pain by referring to the "Five D's" syndrome. Chronic pain patients are usually involved in a cycle of "(1) drug misuse, changes and decreases in physical activity that result in (2) dysfunction, resulting in (3) disuse lesions such as frozen joints. These pain patients as a consequence are (4) depressed. Depression, in turn, makes the chronic pain patient more pain prone. The end point becomes

(5) disability, for which western society provides compensation. The compensation in turn reinforces reduced activity, disuse, dysfunction and drug use, ultimately leading to unbearable suffering" (Weisenberg 1980).

By examining the "Five D's" syndrome of chronic pain a range of motivational, emotional and cognitive variables can be found. Therefore, psychological intervention can have a great impact upon pain perception.

### THEORIES OF PAIN – PHYSIOLOGICAL AND PSYCHOLOGICAL

"Although sensory perception has long been recognized as a psychological process, it is only recently that the perception of pain has come to be recognized as a significant psychological problem of clinical concern" (Weisenberg 1980). Very often when talking about pain, psychologists have to adopt a dualistic language because sometimes it is easier to talk about pain using physiological terms and other times psychological explanations have to be applied.

Early theories of pain relate only to physiological or neurophysiological mechanisms. Later, the question of whether it is correct to equate sensation with perception leads to the realization that there may not be a one-to-one relationship between sensory input and the subjective experience of pain. There may involve higher level processes.

The early theories regarded pain as arising from the relatively direct transmission of signals from "nociceptors" to pain centres in the brain, and the receptors, pathways and centres involved were thought to be specific to pain (Griffiths, 1981). In 1826 Müller observed that a given nerve fiber leads to a certain class of sensory experience whenever and wherever the nerve is aroused. However, Müller's doctrine has been difficult to confirm because "the various sensory receptors in the skin seem to show relative rather than absolute specificity as regards the experiences their stimulation elicits" (Norton, 1982).

Problems arising from the specific model prompted later alternative formulations, collectively referred to as pattern theories. According to these theories, there is no specific pain receptor but rather, pain stimuli lead to specific pattern of responses among the various cutaneous receptors. This in turn lead to the perception of pain centrally Stimulus intensity and a central process of summation are the key factors in the process. Furthermore, there are two cutaneous systems, one fast acting and the other slow. Under normal circumstances the fast system inhibits the slow; in pathology the reverse happens, leading to pain events (Norton, 1982).

Since both specific and pattern theory rely ultimately on peripheral stimuli being essential to pain experience, Melzack and Loeser (1978) found



them inadequate in explaining the phenomena of phantom limb pain in the lower extremities which persisted after cordectomy (removal of a portion of the spinal cord) and isolation of the sympathetic ganglia. In such cases, pain is inexplicable on the basis of any sort of peripheral receptor-cord-brain formulation. In 1965 Melzack and Wall formulated the Gate control theory which suggests that the stimulus for pain is a summation of incoming events in particular lamina of the spinal cord, which are inhibited until they reach a critical level. The gate referred to is a hypothetical mechanism at the level of the spinal cord, which is assumed to modulate signals from the periphery before they are centrally processed. It is situated in the substantia gelatinosa and has its effect by inhibiting or facilitating the transmission of signals from the dorsal horns to the adrenolateral pathways of the spinal cord. Activity in peripheral fibres will not only influence the transmission of pain signals directly but also affects the operation of the gate, as can central brain processes. Activity in the large, myelinated fibres tends to inhibit transmission from the spinal cord transmission cells (ie. closes the gate) whereas small fibre activity tends to facilitate transmission. The spinal gating system is also subject to descending influences from the brain. This model is a complex and dynamic one, and can hence explain many diverse phenomena. It incorporates both physiological and psychological characteristics. This theory has been influential in recent years.

#### PSYCHOSOCIAL INFLUENCES

Weinman (1981) maintained that psychosocial factors can have great impact on the perception of pain. When studying cultural differences within the USA, Zborowski (1952) found differences both in response and interpretation of pain. The "old Americans" shared an accepting, rather stoic attitude and did not respond so overtly as Jewish or Italian Americans. Furthermore, the Jews differed in that they were more concerned with the meaning and implications of the pain while Italians with obtaining immediate relief. Woodrow et al. (1972) found that whites tolerated more pain than blacks who in turn tolerated more pain than Orientals. Dramatic cultural differences can be seen in the reactions of women to childbirth. In Western culture it is associated with pain and in others it is not. There are even some tribes in which it is the men who experience the greatest pain during childbirth. These differences cannot be explained in purely sensory terms. They reflect "different cultural attitude towards specific and general pains" (Weinman 1981).

The ethnic differences point to the role of the socialization process which determines the attitude towards pain. This furthermore indicates the importance of past experience in the response to a sensory stimulus. Melzack (1973) maintained that early experience plays an important role in pain

perception. For example, different socialization procedures for boys and girls result in the expectation that men should be able to tolerate more pain than women. However, when women give birth to babies, the significance of the "present context" influences pain responses. The influences of the context may be partly due to the extent to which the individual's attention is focused on the pain or not and the extent to which she is prepared for the pain. This can be again easily demonstrated by comparing pain received by a well-directed kick under the dinner table and that which, although of same intensity, is received while scoring a winning goal. Furthermore, Beecher's study (1959), described earlier, proved that the psychological impact of tissue damage sustained within the context of the battlefield could be quite different from equivalent damage sustained in a situation not normally associated with injuries.

Other factors influencing perception of pain can be emotional state and personality of the patient. Bond and Pearson (1969) studied a group of women with carcinoma of the cervix, found that pain-free patients were more sociable and rated less emotional than a group who felt pain but did not complain. Those patients who were rated both emotional and sociable were those who complained of the pain and also received more medication. In laboratory studies extroversion has been associated with high pain tolerance and introversion with a greater sensitivity to pain. Even in childbirth, more introverted mothers have been found to feel pain sooner and more intensely but to complain less.

Finally, the potency of the "placebo" effect provides the strong evidence of a major psychological component in the experience of pain. This may partly explain the "wonder drug" phenomenon, in which a new drug may be found to be particularly effective only during the initial period of its use (Weinman, 1981).

#### PAIN MANAGEMENT

According to Norton (1982), a distinction can be made between adaptive pain and morbid pain. The former serves as a signal and leading to health enhancing behaviour. The management in this case will take an etiologic approach which is consistent with the disease model – by eliminating the underlying cause the symptoms will end. Morbid pain serves only as a symptom of underlying pathology and leading to no adaptive behaviour. The treatment is a symptomatic approach dealing with the subjective experience of pain. This usually involves the use of analgesics. Other treatments may involve neuro-surgical procedures or the recent behavioral treatment proposed by Fordyce in 1976, which emphasizes "well behaviour", exercises and dissociation of pain dedication from pain behaviour.

Since the treatments the present patient group is receiving is either orthopaedic surgery in

straightening the back or analgesics to reduce pain, so it may be appropriate to talk about the effectiveness of drug and other psychological or psychosocial factors involved. Beecher (1959), Melzack (1973), Chapman (1978) and others have shown laboratory study of pain as a simple sensation is not adequate for the understanding of clinical phenomena. Many psychological variables like emotional arousal, motivational drive and cognition influence the final perception of pain.

Szasz (1957), Zborowski (1969) and others have pointed out that in discussing human reactions to pain, communication aspects are frequently overlooked. These aspects may at the first level be straight forward facts about the symptoms. The second level is using the pain complaint as a cry for help. These two levels are tied. The third level is different. Pain can be viewed as a symbol of rejection where the request for help has been frustrated. Pain complaints can become a form of aggression and means of atoning for guilt. (Weisenberg, 1980) Furthermore, as a result of the "Five D's" syndrome of chronic pain (Brena, 1978) "much of the prescribing of potent analgesics and narcotic is based on the feeling of hopelessness, helplessness, and a desire to have a reason to maintain doctor-patient contact." (Weisenberg, 1980) However, when pharmacological means are used to control pain, the psychological status of the patient will often determine their chemical effectiveness. As Beecher (1972) has stated "some agents are effective only in the presence of a required mental state."

Chronic pain patients who have depended on analgesics for a long period of time may knowingly or unknowingly adopt a "sickness role". This is the person whom Szasz (1968) refers to as *l'homme douloureux* (*homo-dolorosus*), one who has made a career out of his pain. Such individuals give up their former careers when they fail or are no longer sustained by them, to take on a career of suffering. They don't want to give up their suffering so the doctors have the responsibility to detect such tendency and refrain from helping in the creation of a sick man. However, Sternback (1974) disagrees with Szasz regarding *l'homme douloureux*. He feels that the career pain patients do suffer terribly and would like to give up their suffering.

### 3 PRELIMINARY INTERVIEW

Three patients were randomly selected for interview for the purpose of obtaining more information before setting questionnaires.

Although interviewing is time-consuming and expensive, yet it is sometimes the only way to obtain the information necessary to a research study. It has certain advantages and one of the greatest is depth. Researches can go below the surface of responses, determining reasons, motives and attitudes (Kerlinger, 1979).

All three patients were male (the majority AS patients in H.K. are male). The first patient was 26, a university graduate and a teacher. He had suffered from AS for 12 years. He is slightly deformed (bent back). He revealed a constant awareness of the pain and disturbed daily activities. In order to keep his job, he kept his illness a secret and consequently had to make preparation in school for any change of movement or gesture which resulted constantly in pain and yet had to be concealed. Recently, he had to forfeit the offer of a postgraduate training post for fear of not able to keep the present teaching post.

This fear was due to unpleasant experiences received during job interviews. He felt the employers looked down on him when they found him deformed. They made him walk and turn around. These inspections were humiliating to him. Furthermore, when employers learned that he was suffering from this disease, he was rejected. The present employer only presumed that he was suffering from some sort of in-born deformity rather than a progressive and deteriorating disease.

He had given up the idea of marriage and never taken initiation in courting. The reason given was that if he were to get married, he would have to find someone equally deformed (if not more).

He lived with his parents but they never discussed his illness. His coping strategy seemed to be to immerse himself totally in his teaching which he found quite rewarding at times. He stressed self help for he disliked being treated as an invalid.

The second subject was 35 and jobless. He had had the disease for 14 years. One of his hip joints had been replaced. He put the on set of the disease down to over-work and too much exercise during adolescence. At first the pain was unbearable but after operation and intake of analgesic it was more tolerable. However, the drug had side effect, especially to his stomach.

Due to the pain he had to give up the job in the factory and lived on Public Assistance. He shared a room in the public estate building with another handicapped person. Recently, he got married to a girl suffering from Cerebral Palsy. They found inconvenience in the sharing of accomodation as the room was only separated by a curtain and they had no privacy. Furthermore, they had sex problem as the wife had a painful and stiff hip joint. She would be operated on soon and it might solve this problem.

He had not been working for a long time and had quite accepted his disability and deformity. When the pain attacked him, he would do exercise to relieve the pain in the chest.

The third patient, aged 30, worked as an auditor and had the disease for 7 years. He showed no physical deformity. He was accompanied by his wife during interview. Both seemed to believe that the disease was the result of tension at work and long hours of bending over calculation.

During the initial attack, he experienced great pain all over the body and high fever. After hospitalization and medication the joints were loosened and the pain made less severe.

He was married for three years and had no children yet for they worried about hereditary factor. Their main worry was how to keep the present employment. He was informed by the doctor that he needed to be hospitalized again. He had already stayed away from work for two months due to the pain. Although the employer was quite sympathetic, hospitalization and long leave might make him start questioning his ability and later performance. They were afraid of losing the job.

## 4 1ST PART OF RESEARCH – QUESTIONNAIRES

From the interviews, apparently, the important issues were constant pain in varying intensity, which could be so intense at times that they were referred to as flare-ups, and constant worries. These worries would be related to work, marriage/sex, and activities/movements resulting from deformity.

Some feared losing their jobs which would cause financial problems especially if they were married. Others, who lived on Public Assistance suffered boredom for being jobless and might feel inferior. Hence, there is the need to look into the effect of pain on their work.

Another aspect of life that was affected was leisure activities. The first patient reported to have pain and difficulties during outings. So other daily difficulties might presumably be present and caused problems for them.

For the married one (2nd patient) there was indication of sexual problems which seemed to result from pain and deformity. The unmarried one (1st patient) expressed intention of remaining single. How prevailing the two problems were needed investigation. The reluctance to marry revealed doubts in getting a "normal" functioning spouse and the possibility of hereditary influence on the children. The third patient also expressed this worry and this might explain why the couple rather accepted overwork and long hours of bending as the causes of the disease than genetic endowment. At the initial examination he would have taken and been explained about the test (HLA B27 antigen) and since he had been hospitalized before, there could not be a lack of knowledge about his condition. So this could be a reluctance on the part of the patient to know the truth.

These doubts and reluctance would create negative feelings like frustration or depression especially when in pain. This would also be true for the first patient who had to keep his disease a secret in his working environment. Finally, patients mentioned about pain coping strategies. These would also be dealt with.

The first part of the research would be in the form of questionnaires designed to gather data about how this disease and subsequent pain affected work, activities and sex. Medical history would also be obtained, e.g. duration of the disease and location of pain. Emphasis would be made concerning the emotion felt during attacks and the general coping strategies. (Appendix A, B)

The McGill Pain Assessment Questionnaire had been used as reference during the construction of questions. Not the whole original questionnaire was adopted because some parts were useful while others were irrelevant. For example, Fig. 3A (P. 292), personal information and Fig. 3B and 3C, the medical history were already recorded by the hospital staff. Some details were quite different for they were unique and applicable to this patient group only, e.g. results from HLA B27 antigen.

There was no need for information on ethnic group as they were all Chinese. In Fig. 3D, only marital status would be useful in relation to sexual problems and marriage viewpoints (question 15 in the questionnaire). The "Present Pain Pattern" section would be modified into the self-rating in Part II (3 weeks longitudinal study) which will be discussed later. The part about mood change corresponded to question 4 which investigated emotional feeling during pain attacks. The rest of this section in Fig. 3E "Accompanying Symptoms", "Other Present Illness" etc. were irrelevant.

Fig. 3F contained "Pain and Sleep" and would be detected by Part II (the interval between intake of analgesic and waking in the morning e.g. 2 hours, would signify disturbance in sleep by pain). "Pain and Sexual Relations" and "Pain and Work/Activity" were modified into questions 15 and 6/13 respectively.

In Fig. 3G, the most relevant part was (B) and this formed one of the methods for measuring pain intensity in Part III. The reasons for discarded Fig. 3H, the 102 pain terms will also be discussed in Part III.

Fig. 3I formed question 12, the location of pain and the "Home Recording Card" was similar to Part II of the present study.

By using information gathered at the Preliminary interview and the McGill Pain Assessment Questionnaire as a guide line, the questionnaire for Part I was designed and administered individually to 63 patients. The data were collected during five out-patient clinic sessions at the hospital.

Verbal instruction was given by the experimenter to each patient separately and assistance in some written part was necessary for some patients. After completing the questionnaire, the patient was given a folder containing instruction and material for Part II of this research. This will be explained later.

## 5 RESULTS FROM QUESTIONNAIRES

To investigate the relationship between years of having the disease (AS duration) and the emotional feelings, Kendall Correlation Coefficient was applied and the strength of relationship between AS duration, hopeless, depressed, frustrated, irritated, resistant and indifferent were obtained as shown in Table 1A.

Table 1A

	AS duration	hopeless	depressed	frustrated	irritated	resistant	indifferent
AS duration		** tau=.23	n.s. tau=.12	n.s. tau=.01	n.s. tau=.04	n.s. tau=.04	n.s. tau=0.5
hopeless			*** tau=.50	** tau=.33	** tau=.32	n.s. tau=.12	n.s. tau=.08
depressed				*** tau=.39	*** tau=.36	n.s. tau=-.19	n.s. tau=.10
frustrated					* tau=.25	n.s. tau=-.08	n.s. tau=-.03
irritated						n.s. tau=.05	n.s. tau=-.09
resistant							n.s. tau=.03
indifferent							—

n.s. non-significant                      D.F. = 61  
 \*    P < .05  
 \*\*    P < .01  
 \*\*\*   P < .001

Friedman One-way Anova yielded results shown in Table 1B. There was significant difference between the ratings given on six emotional feelings. The patients rated "depressed" as the most frequently felt feeling during pain attacks.

Table 1B

	hopeless	depressed	frustrated	irritated	resistant	indifferent
mean ranks	2.65	4.10	3.94	3.75	4.04	2.52

$X^2=46.345$                       D.F. = 5                      P < .001

To determine whether differences in educational level were related to the ability to obtain jobs, the  $X^2$  test was employed. The  $X^2$  in table 2A indicated non-significance, meaning the ability to obtain jobs did not depend on the patient's educational level. Although more patients had secondary education but in each level there was fairly even distribution of those with or without jobs.

**Table 2A**

Relationship between Educational level and Job

Educational Level	Without Job	With Job	
Primary	9	12	2
Secondary	14	23	37
Tertiary	2	3	5
	25	38	63

$X^2 = .14123$       D.F. = 2      non-significant

Table 2B showed a slight greater percentage of patients who were not satisfied with their jobs (54%). Those who were jobless (63.5%) attributed the main reason to pain (Table 2C).

Table 2D revealed the mean AS duration as 9.302 years. One patient had been ill for 35 years. On the average, patients kept the same job for nearly 5 years, with the maximum being 25 years. However, many had to change jobs. The average number of changes during their working life was 1.362 times with maximum of 8 times.

**Table 2B**

**Patients with Job**

	absolute frequency	relative frequency %
Satisfied	29	46
Not Satisfied	34	54
Total	63	100

**Table 2C**

**Patients without Job**

	absolute frequency	relative frequency %
Due to pain	40	63.5
Due to other reasons	18	28.6
Students	5	missing

**Table 2D**

Variables	Mean	Std. dev.	Min.	Max.
Years of having AS (AS duration)	9.302	6.586	1	35
Years in holding to the same job (Job duration)	4.778	6.371	0	25
No. of times of Job change	1.362	1.88	0	8

Table 3A and 3B indicated significant differences among the daily difficulties. Each patient could have different difficulties e.g. some might find putting on shoes difficult while others had problems with putting on clothes. However, most patients found getting out of bed the most difficult due to long hours of lying down.

**Table 3A**

**Daily Difficulties**

	getting out of bed	cleaning face & teech	dressing	putting on on shoes	going to toilet	bathing
No. of patients	48	8	27	36	17	17

**Table 3B**

Daily Difficulties	Answers	Absolute frequency	Relative frequency %
getting out of bed	Yes	48	76.2
	No	15	23.8
cleaning face & teeth	Yes	8	12.7
	No	55	87.3
dressing	Yes	27	42.9
	No	36	57.1
putting on shoes	Yes	36	57.1
	No	27	42.9
going to toilet	Yes	17	27.0
	No	46	73.0
bathing	Yes	18	28.6
	No	45	71.4

In table 4A and 4B, hip and waist regions were the most common location of pain. Very often, a patient could report more than one location.

**Table 4A**

**Pain Location**

	leg	hip	waist	back	neck
No. of patients	24	43	40	31	28

**Table 4B**

Location	answer	absolute frequency	relative frequency %
leg	Yes	24	38.1
	No	39	61.9
hip	Yes	43	68.3
	No	20	31.7
waist	Yes	40	63.5
	No	23	36.5
back	Yes	31	49.2
	No	32	50.8
neck	Yes	28	44.4
	No	35	55.6

Many patients complained that due to pain they had to give up the leisure activities they enjoyed. About 63.5% indicated that there was a change in the leisure activities since they had the disease. This was shown in Table 5.

**Table 5****Leisure activities**

		absolute frequency	relative frequency %
leisure activities	affected	40	63.5
	not affected	23	36.5
Total		63	100

Marital status was shown in Table 6A with 50.8% of patients being single. These patients had gloomy viewpoint about marriage. In Table 6B only 28.1% indicated a wish to get married. 31.3% had already given up marriage and 40.6% had doubts. Among the married and divorced, 48.4% admitted that pain had affected their sex life. (Table 6C)

**Table 6A****Marital Status**

Marital status	absolute frequency	relative frequency %
Divorced	2	3.2
Married	29	46.0
Unmarried	32	50.8
Total	63	100

**Table 6B**

**Marriage viewpoints affected by pain & AS**

	absolute frequency	relative frequency %
given up marriage	10	31.3
have marry	13	40.6
will marry	9	28.1
Total	32	100

**Table 6C**

**Sex affected by pain among married & divorced patients**

	absolute frequency	relative frequency %
Sex affected	15	48.4
Sex unaffected	16	51.6
Total	31	100

Among the three pain reduction methods, patients generally preferred or would resort to self-medication and less to exercises. There was great difference among the choices. (Table 7A, 7B)

**Table 7A**

	see doctor	self-medication	exercise
No. of patients	25	46	17

**Table 7B**

Methods	Answers	absolute frequency	relative frequency %
See doctor	Yes	25	39.7
	No	38	60.3
Self-medication	Yes	46	73.0
	No	17	27.0
Exercises	Yes	17	27.0
	No	46	73.0



## 6 DISCUSSION

Despite the correlations amongst hopeless, depressed, frustrated and irritated, AS duration only correlated with hopeless and not the others. This could be attributed to a third variable, knowledge of the incurability of the disease. The longer these patients had the disease the more disillusioned they would be of any real cure. Since some patients had been ill for as long as 35 years and the mean duration was 9.3 years so knowledge would have accumulated. From the gradual change in location of pain and intensity, together with signs of deformity, they would eventually question their physicians and obtained definite knowledge about the course of deterioration. Although the final outcome might vary yet if knowing that they would not be cured, a feeling of hopelessness would result.

The four emotions; hopeless, depressed, frustrated and irritated were correlated among themselves indicating that they were measuring similar feelings during pain attacks. These feelings were yielding and giving in to the unbearable suffering. Resistant and indifferent were of different kinds of attitudes. "Resistant" indicated a strong fighting spirit and desire to reduce pain. "Indifferent" signified ignoring or a pretence of its non-existence. These two feelings neither correlated with AS duration nor the other emotions.

The Friedman one-way anova (Table 1B) indicated differences among the six emotions. Referring to the mean ranks, hopeless and indifferent were rated lower than depressed, frustrated, irritated and resistant. Only those who had the knowledge and the length of suffering would feel hopeless and possibly indifferent. Others might have accepted pain as part of their lives. However, for most patients, they would be governed generally by depression, frustration, irritation or resistance during the attacks. Depression was rated the highest. At times it could be so great that a few patients reported suicidal tendency. One patient was unable to complete the third week self-report on pain for the second part of this research as he was hospitalized after suicidal attempt. However, instead of giving in, some might want to "fight" the pain and reduce it. These would be the newly affected ones or those who were not too deformed and interested in following exercises taught by the physio-therapists in pain reduction.

Some of the worries in work could have resulted from the disease and pain. Table 2A showed that there was no evidence that higher educational level enabled greater opportunity of keeping jobs. Among the working patients, about half were dissatisfied with their work. The experimenter could not state if 54% was a significantly high figure unless more time were allowed and a more in-depth research with controlled groups was carried out. The main reasons for their dissatisfaction were long hours of standing which resulted in pain, uninterested in the work but had to maintain a living etc. Those who

were satisfied, reported good working relationship with colleagues, sympathetic employers and possessing trained skills.

From Table 2C, 63.5% of the jobless patients lost their jobs as a result of constant pain while 28.6% attributed it to other reasons, e.g. employers thought them unfit for the jobs. Information given by Table 2D showed that some could maintain the same job while others might change up to 8 times in about 10 years. Therefore, one could infer that pain resulting from AS was, to a certain degree related to job dissatisfaction, job changing and joblessness.

Significant differences were found among the various daily activities as shown by Table 3A. The number of patients under each heading revealed that the activities created difficulties to patients in varying degrees. The difference could be a function of the severity of deformity and location of pain. Majority of the patients had great difficulties in getting out of bed and putting on shoes (Table 3B). Patients reported of greater pain when changing the lying down position to sitting and standing up due to the stiffness in the joints and lower lumbar spinal section. Similarly, bending down to put on shoes or lifting the feet up created difficulty and pain.

Patients faced different daily difficulties for they had different location of pain. Referring to Table 4A, 4B, hip and waist were the most common location. Change of posture frequently involved joints and lumbar spine, hence, activities like getting out of bed, bending or putting on shoes and sometimes even standing for long duration would cause great suffering. In certain cases, replacement of hip joints could facilitate movement. When pain and stiffness advanced to the back and neck and resulted in severe deformity, spinal osteotomy would be required. In the present patient group, several had undergone hip replacement and one had spinal osteotomy.

Besides daily activities, pain and its location also affected leisure activities. Most patients (63.5%) admitted that leisure activities they once enjoyed, e.g. ball games, dancing etc were now replaced by TV watching and mahjong playing. (Table 5) Those who claimed that leisure activities were not affected by the disease were the ones who liked reading, listening to music or watching TV before they were ill. Main reasons for the change were pain due to the vigorous movement, difficulty in movement or physical deformity. Some claimed to have less interaction with friends due to pain and feeling of inferiority. One patient in the preliminary interview admitted to experience great pain both physically and emotionally during outings with his students.

Other aspects of life that pain and AS had affected were sex for the married and marriage viewpoints of the single (Table 6A, 6B, 6C). Half of the patient group was married (including 2 divorced) and 48.4% of these admitted that sex was affected by pain and AS. Difficulties were mainly lack of

libido and pain resulting from activities. Since patients were mostly male (59 out of 63) and Chinese, one could appreciate difficulty and embarrassment in admitting having sexual problem to a female experimenter. Therefore, it could be reasonable to assume the real figure to be greater than 48.4%.

Among the unmarried patients only 28.1% claimed to have the wish to get married. The rest (71.9%), either had given up marriage totally or were having doubts. Reasons for this gloomy view on marriage were poor self-image, inferiority, limited social circle, financial difficulty and fear of hereditary factor. Therefore, pain and AS had significantly affected sex for the married and marriage decisions for the single.

Methods of pain reduction, especially during flare-ups, were investigated. The three methods, namely, see doctor, self-medication and exercises were used differently (Table 7). The most common was self-medication which could indicate drug misuse and a psychological dependency. Seeing doctor meant getting drugs too, however, this was not easily available. The special clinic for AS was held only once a week at DKCH and consulting private specialists would be expensive. Therefore, self-medication was preferred. Exercises like hydrotherapy or physical therapy taught by the physiotherapists were only employed by 27% of patients. These findings could be useful when suggestions are to be made later.

The results from the questionnaires apparently indicated that patients' work, leisure, sex/marriage viewpoints and their emotions were affected by constant pain and AS. These difficulties supported the findings by Chamberlain (1980) and Buchanan (1981). They should warrant separate and in-depth researches. The data in the present research can only serve exploratory purposes. If a detailed study about sex/marriage viewpoints is to be conducted then a controlled group will be needed and a more structured investigation will need to be carried out.

## 7 2ND PART OF RESEARCH – 3 WEEK LONGITUDINAL STUDY OF DIURNAL VARIATION OF PAIN

Patients, after filling the questionnaires, were given a folder containing written instruction, 3 charts (one for each week), 3 self-addressed envelopes and a pencil. Verbal instruction was also given to explain how to chart the diurnal pain variation. This was designed in the form of an analogue scale (Wolff, 1978) from 0-100 where 0 meant no pain and 100 indicated unbearable pain. (Appendix C, D and sample folder)

This part focused upon the constant complaint of pain from AS patients. It consisted of a 3-week longitudinal study of pain variation both in the morning and at night.

The experimenter would like to look at the diurnal changes which could reflect the level of pain among this patient group. Furthermore, the duration of three weeks might be sufficient to collect evidence of flare-ups which could be a common phenomenon.

### RESULTS

Among the 63 patients who received the folders, (containing 3 charts, 3 self-addressed envelopes, a pencil and instructions) 54 returned all the charts. However, two sets of data had to be discarded. The first set contained a half-finished chart which was not fully completed for personal reasons. The other patient had spinal osteotomy before and reported of having no pain in the morning or evening but 10-20 degrees of pain during any movement e.g. walking. Therefore, a total of 52 sets of data were utilized.

Using the 52 sets of charts, individual average rating for morning and evening pain were calculated and then the mean a.m. and p.m. pain intensity for the group were obtained.

mean a.m. = 38.31    maximum=100    minimum=0  
mean p.m. = 38.09    maximum=100    minimum=0

Each patients variation was calculated from the difference between the maximum and minimum pain intensity. These subsequently yielded the group's mean variation.

mean variation = 45.865  
maximum variation = 90  
minimum variation = 10

Using 50 as the arbitrary center point of 0-100, more patients had pain level below 50.

mean pain intensity	absolute frequency	relative frequency %
over 50	18	34.6
below 50	34	65.4
Total	52	100

Graphs A, B, C, D indicated diurnal variation with flare-ups which were quite outstanding. There were altogether 16 sets which showed evidence for flare-ups. 25 sets had reports of pain level below 50 with the highest frequency at 20-40. Among these only 5 occasionally had no pain. The remaining 11 sets indicated rather constant pain level of over 50 with a fluctuation of about 10-20 degrees.

S16 Graph A

morning - - -  
night ———

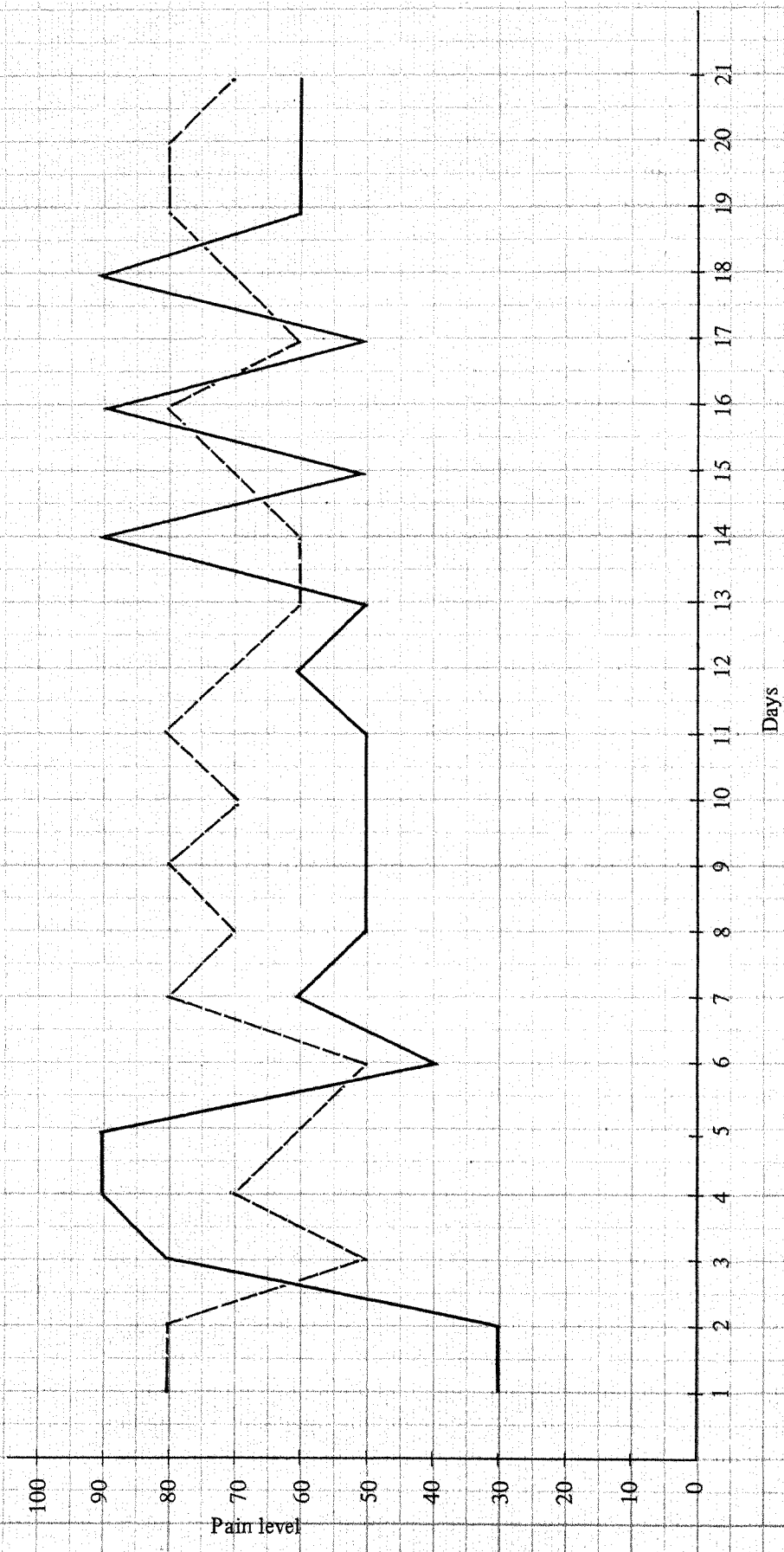

S22 Graph B

morning - - -  
night —

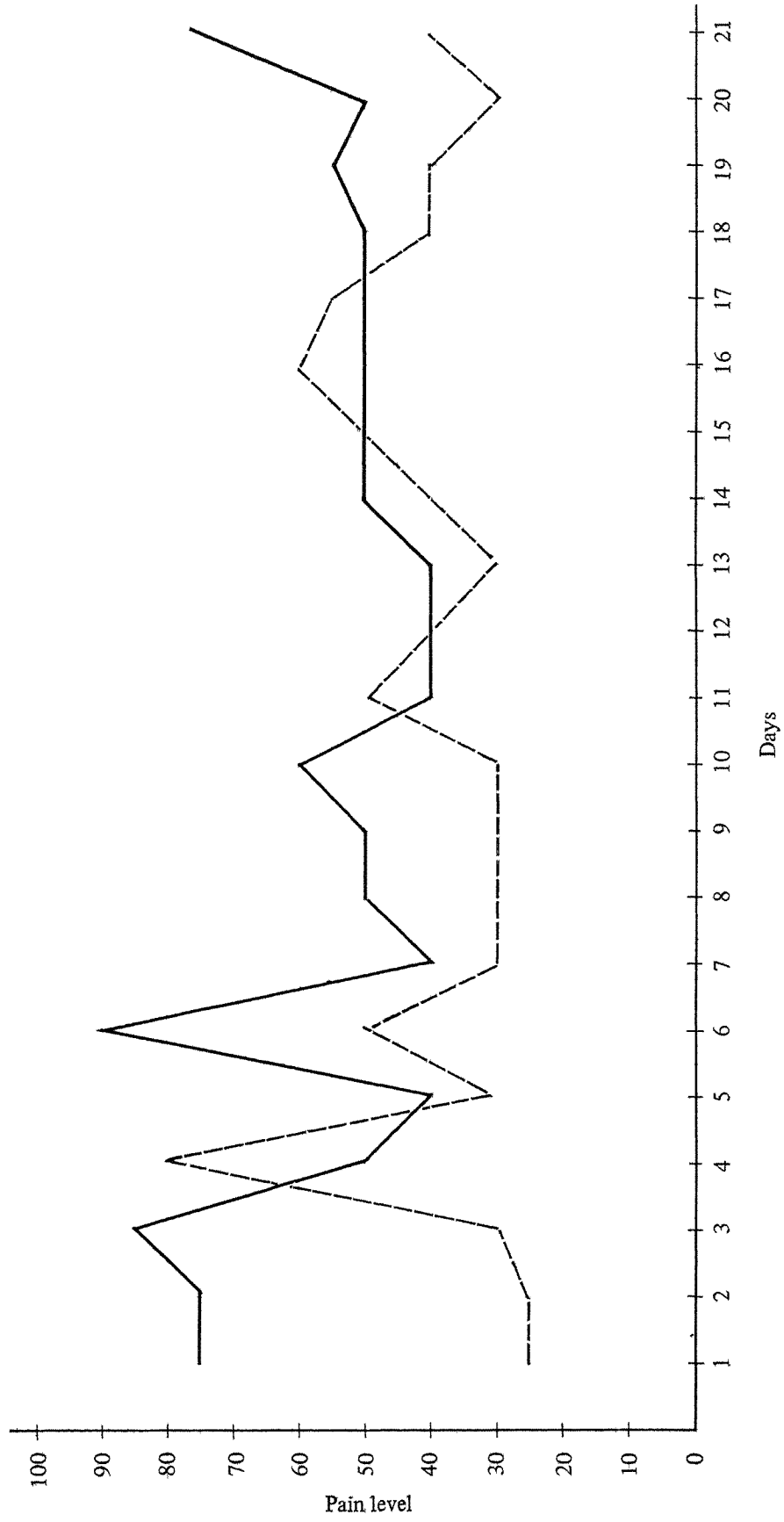

S38 Graph C

morning - - -  
night —

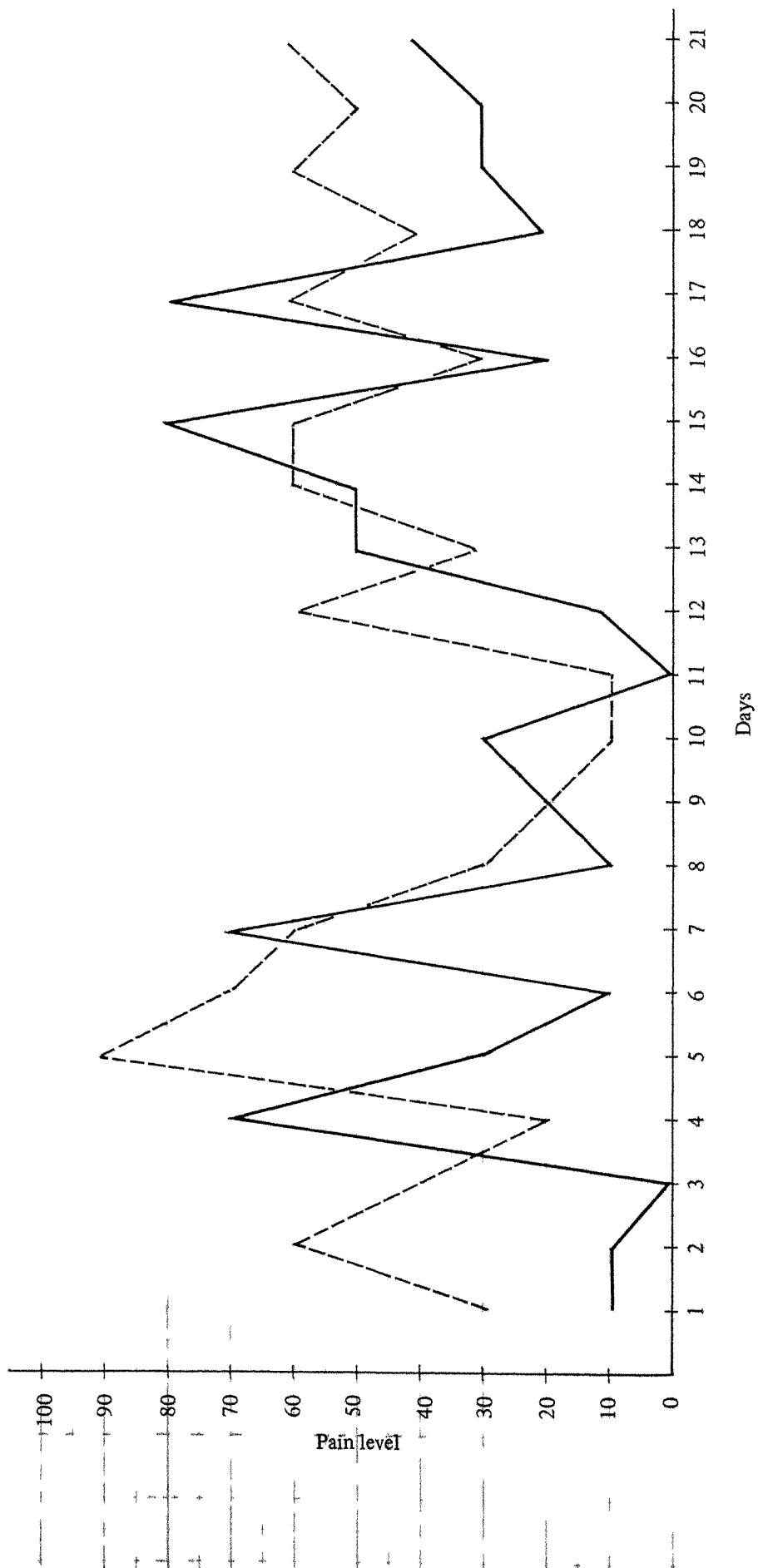

S43 Graph D

— morning  
- - - night

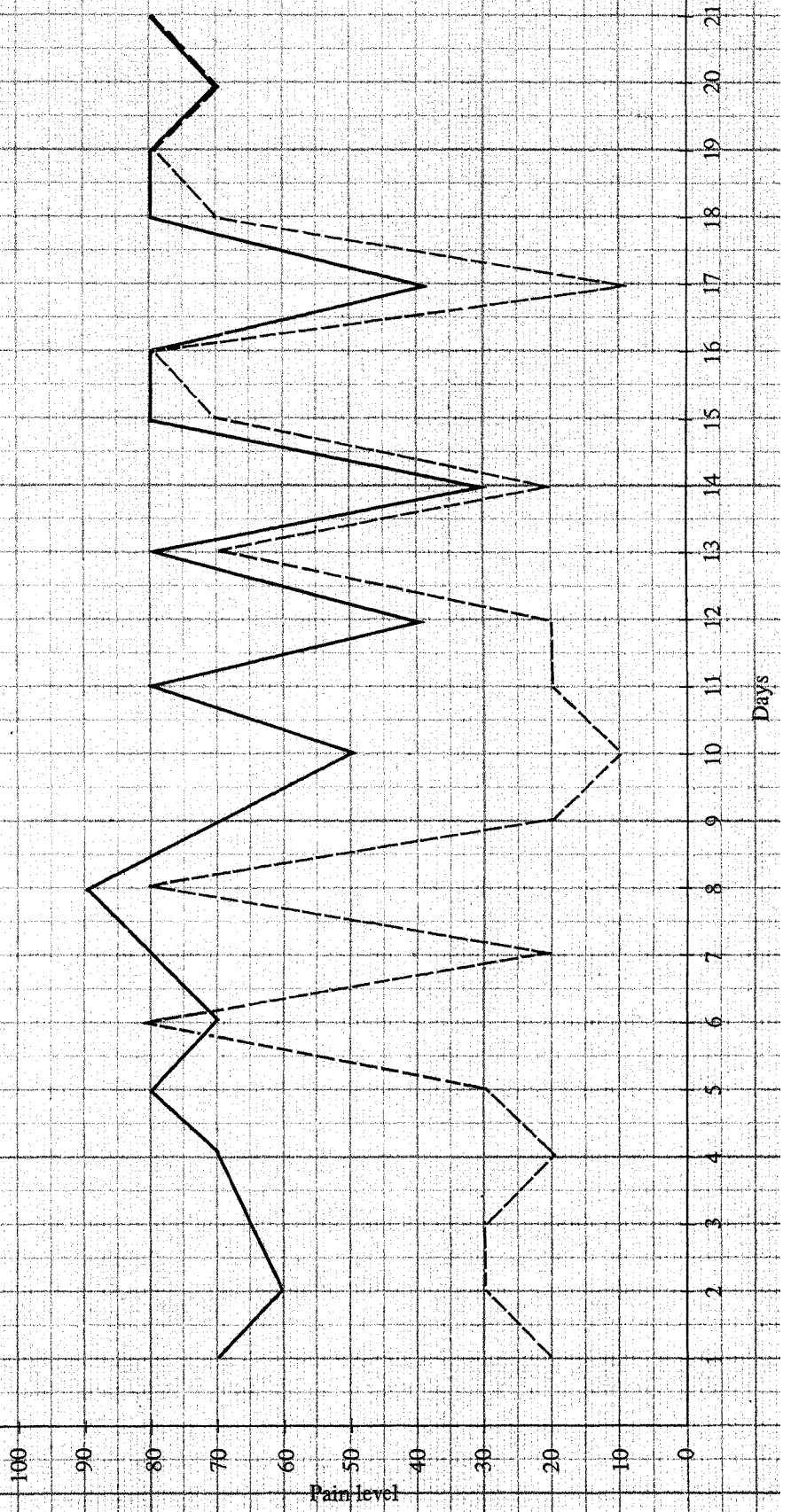

## DISCUSSION

The constant complaint of pain led the experimenter to hypothesize that there should be great variation and high intensity found among the patients. However, from the calculations and results obtained there was indication of average pain of less than 40 for both morning and evening recording. Mean variation for the group was 45.865 which was below the experimenter's expectation. But the group mean could not fully explain individual experience. Furthermore, there could not be any set standard of pain tolerance. Some individual reports revealed great fluctuation and differences in variation over the three weeks. There were flare-ups which could cause severe pain. With analgesic intake and gradual recovery, the pain would dissipate, yielding 0 degree (Graph C). Some patients experienced more pain in the morning than evening. The frequent dosage of analgesic during the day added to this effect. Further footnote put by a patient (No. 58) in the chart indicated sleep disturbance due to pain in the second week and non-significant effect of analgesic in the third week. He was hospitalized after the following examination at the clinic.

Many patients (65.4%) had pain level below 50. Some even had minimal pain. These could be due to the control of the inflammation and analgesic intake. Also for some, this could be the recovery period or even stabilization. Another explanation could be illustrated by referring to detail information given by patient No. 21. When approached by experimenter, the patient claimed that the pain level corresponded with the increase and decrease of humidity. When questioned about why the humidity remained over 80% for the three weeks and yet the pain level was not correspondingly high. It remained around 20. Explanation given was that the previous terrible experience of unbearable pain which resulted in long period of hospitalization had an effect on any subsequent pain, making it quite bearable and insignificant by comparison.

Among the 34.6% who had pain level over 50, 16 experienced flare-ups and 4 of these showed interesting and outstanding evidence for flare-ups. (Graph A, B, C, D) Although in Part I of the research, most patients admitted to have difficulty in getting out of bed due to stiffness and pain, yet Graph A and Graph D indicated a rise in pain level in the evening due to the nature of the work (too much walking or standing). This was most aggravating during flare-ups as the effect of analgesic could be minimal. The duration and pattern of the flare-ups differ individually. A few had gradual increase and decrease while most had sudden "spurt" which was severe and lasted a few days only. The pain level during the flare-up would be high for both morning and evening although some might experience more after long hours of lying down while others more in the evening after long hours of work.

Patient No. 16 (Graph A) had two flare-ups. The first one lasted 3 days and the second one had intermittent pain over 5 days. The pain was more severe in the evening. Patient No. 22 (Graph B) had one severe attack and the pain was also more in the evening. Patient No. 38 (Graph C) experienced high level of pain during the attacks and had very low or no pain at all during the intervals. Patient No. 43 (Graph D) was constantly having great pain in the evening throughout the 3 weeks. Long hours of rest seemed to ease the pain except for a few mornings.

These four examples were only used to illustrate incidents of flare-ups. Generally patients had constant pain of varying levels. For example, among the 25 sets of reports which showed constant level of pain below 50, two patients reported no pain throughout the 3 weeks except for an occasional rise in a few days. The rest experienced pain of little variation in intensity. The fluctuation would be within 30 degrees. The same was true for those 11 patients whose pain level remained above 50.

Hence, although the group average pain level was not as high as the experimenter had expected yet nearly all had constant pain of varying intensity. Among them 16 showed evidence for flare-ups. In general, there was much individual difference found in tolerance of pain, diurnal variation, flare-ups etc. This was due to the subjective nature of pain.

## 8

### 3RD PART OF RESEARCH — MEASUREMENT OF PAIN INTENSITY BY DIFFERENT METHODS

When patients attended the out-patients' clinic at the Duchess of Kent Children's Hospital, they were asked to rate their pain on three levels, namely, mild, moderate or severe. According to the doctor in charge of the study, every patient complained of pain and yet since there were many other examinations involved e.g. X-ray, blood-test, physical examination, enquiry about effectiveness of prescription etc., only simple indication of pain could be performed. This measurement obviously had severe limitations. The information it gave was scanty and very subjective. Furthermore, it offered insufficient comparison or variation from previous diagnosis unless the patient was having a flare-up. So it was not helpful to the doctor in increasing or decreasing analgesic dosage.

Hence, the experimenter would investigate three methods of measuring pain intensity. The first method was modified from the section of "Present Pain Intensity" in the McGill Pain Assessment Questionnaire. The second method; the Analogue Scale, and the third; the Toumiquet Pain Ratio will be discussed in later section.

According to the McGill Pain Assessment Questionnaire developed by Melzack and Torgerson

(1971) and Melzack (1975), clinically, pain is described by patients mostly in verbal terms. There are different expressions in English e.g. aching, stabbing, pounding, throbbing or unbearable, distressing, excruciating etc. The 102 pain terms in the questionnaire could be categorized into three classes: "(1) Sensory quality descriptors in terms of temporal, spatial, pressure, thermal, and other properties" e.g. pounding, spreading, crushing, burning, aching, etc. "(2) Affective quality descriptors in terms of tension, fear and autonomic properties" e.g., exhausting, awful, nauseating, etc. "(3) Evaluative terms that describe the intensity of the total experience" e.g. agonizing, excruciating, miserable etc.

Variety of studies have been performed using McGill Pain Questionnaire or similar techniques. Weisenberg (1980) maintained that they indicate "an encouraging step in the right direction", in measuring pain "There are, however, those who might argue that use of scales such as the McGill Pain Questionnaire would be most appropriate for patients with good verbal skills, but not for those without such skills" (Weisenberg, 1980). Problems arose in adopting the "Pain Description" section. Only B part of Fig. 3G, P. 270, could be used to measure pain intensity. Two of the statements (pain at its worst and pain at its least) were found to be irrelevant and unrealistic. This was due to the fact that most of the AS patients in the present study have been suffering pain for over 10 years. They would find it difficult to rate the worst incident which usually would be unbearable. Therefore only four statements were adopted from the original version, namely, present pain, worst toothache, worst headache, and worst stomach-ache. Against these statements, patients had to give a rating from 1-5, where 1 indicated mild pain and 5 excruciating pain. The numbers represented pain in increasing intensity.

Great difficulty was found when attempting to translate Fig. 3H, the 102 pain terms. Most of these terms had no appropriate Chinese translation and the direct translation of some from the dictionary would be allient to Chinese both in meaning and applicability. Therefore, besides practical difficulty there was also the problem of cultural differences. Chinese do not describe pain in the same way and terms as the McGill one.

Chinese are not so in touch with psychological feeling. This is reflected by the fact that psychiatry was largely neglected in the China mainland prior to 1949 (cf. Kleinman and Lin, 1981). Most of the studies done on Chinese were based on those in Taiwan or the hua ch'iao (overseas Chinese). According to Lin (1981) Chinese tend to somatize and peculiar example is Shen-K'uei (defective or weak kidney). There is no systematic study on pain or pain perception among Chinese. Hence, experimenter obtained information on the description through

interviewing patients, orthopaedic doctors and other clinicians. The terms Chinese patients applied were mainly sensory. Affective and evaluative qualities were omitted. Since an equal translation was impossible, experimenter could only quote some examples to illustrate the difference. The common terms on pain used in orthopaedic setting would be "yim-yim-tung", "monk-monk-tung", "yuen tung", "cheung tung" (swelling or filling pain), "jok-jok-har-tung", "jump-kut", "chek-tung" (shattering and could not breathe) and "shuen-tung" etc. So terms in McGill Fig. 3H, e.g. hot, shooting, searing, dull, sickening, fearful, blinding, troublesome, torturing, cold etc. would be meaningless to Chinese when pain is concerned. Furthermore, the McGill was applicable to pain of different etiology e.g. Melzack (1975) admitted that group 19 in Fig. 3H was most frequently selected by dental patients. Therefore, many of the terms could not be applied to orthopaedic patients, especially those suffering from AS. Hence, this section was not included in the present study. Instead, Fig. 3G, part B was modified and used as one of the methods.

**McGill Pain Assessment Questionnaire (Fig. 3G)  
Pain Description:**

B) The following words represent pain of increasing intensity

1	2	3	4	5
Mild	Discomforting	Distressing	Horrible	Excruciating

Choose the number of the word which best describes:

	Your pain right now
	The worst toothache you ever had
	The worst headache you ever had
	The worst stomach-ache you ever had

(Your pain at its worst. Your pain at its least.) These two statements are omitted. Chinese version refer to Appendix E.

The second method involved using the Analogue Scale designed by Wolff (1978). He used the visual analogue scale to overcome language barriers. It consisted of a straight line, the ends fixed by a statement of the extreme limits of the sensation to be measured. In the present study, the method used was that one end was to represent no pain while the other end represented unbearable pain.

Scott and Huskisson (1976) recommended these scales as the best available method for measuring pain or its relief (Weisenberg, 1980). Bond (1979), however, warned that the analogue scale could be



“open to the influences of personality, the effects of expectation by the doctor upon the patient’s performance and various other factors in the immediate surroundings”.

Furthermore, Sternback (1974) pointed out the possibility of psychological and cultural influences affecting pain estimate. Therefore, according to Sternback (1974) it would be “helpful to introduce a painful physical stimulus against which the patient may match his clinical pain level. This would not eliminate the subjective response, but the introduction of the painful stimulus into the patient’s judgement, for comparison, should make the measure of clinical pain more accurate”. The Submaximum effort tourniquet technique first developed by Smith et al. was adapted in Sternback’s program.

The Tourniquet technique enabled the patient to give comparison judgement while Analogue scale yielded absolute judgement. So the first was a magnitude matching and the second a magnitude production. Analogue, unlike Tourniquet, was designed with equal intervals which needed two end points 0 and 100. These were only arbitrary and convenient reference point rather than a true zero point in the case of Tourniquet. Furthermore, Tourniquet based on a reference scale which enabled clinicians to obtain a relationship of a patient’s clinical pain level to the maximum he could tolerate. Analogue, on the other hand, was determined by the subject’s own experience. Hence, it was unrealistic to ask for imagination of “unbearable pain” which in reality was not experienced by anyone. So it was obvious that comparison judgement was better than absolute.

Hence, this was the third method adopted in this study. The essence of the method was that blood was drained from the nondominant arm by means of a tight rubber bandage. The state of limb ischaemia was maintained by applying a blood pressure cuff on the upper arm and inflated well above systolic pressure. The rubber bandage was then removed. The patient started to squeeze a hand exerciser slowly and a stopwatch was started. The patient would report when the pain equalled his clinical pain in intensity (even though it might be a different kind of pain). The clinical pain level was reached and time recorded. The patient again would report when the pain became unbearable. This second time was recorded and the cuff quickly deflated and removed.

The tourniquet pain ratio score was computed by dividing the time to reach the clinical pain level by the time to reach the maximum tolerance, and multiplying the result by 100.

Tourniquet technique proved to be useful because “in addition to having the practicality desired, it mimics the duration and severity of somatogenic pain, and even in experienced subjects with little anxiety it produces the marked autonomic changes which frequently accompany pain of pathological origin (Sternback et al. 1974).

The three methods: modified “pain description”, from McGill Pain Questionnaire, the analogue scale and the Tourniquet Pain Ratio, were compiled and administered to 3 in-patients and 16 out-patients. Patients rated the first two scales themselves but the times of pain level and computation of the Ratio were first recorded by experimenter and entered later. (Appendix F)

From the data obtained, a comparison of the methods will be performed. Expectations are that the three methods differ in the value of the data obtained although they are all measuring pain. Correlation will be found between the scales and the Tourniquet will be more objective a measurement than the other two.

## 9 RESULTS

To compare the three methods of measuring pain intensity, the results from the three in-patients were shown in Graph A, B and C and the circadian rhythm on Graphs D, E and F.

Further comparison of these methods were performed on 16 out-patients. In order to find out if the three methods of measuring pain intensity were significantly different One-way between - subject Anova tests yielded the following results.

**Table 1**  
**Comparing McGill and Tourniquet**

Source of Variation	DF	SS	SS%	MS	VR
Methods	1	4529.9	33.40	4529.9	33.915
Residual	15	2003.5	14.77	133.6	
Total	16	6533.3	48.17	408.3	
Grand Total	31	10571.88	100.00		
Grand mean = 50.6				McGill = 38.8	
Total no. of observations = 32				Tourniquet = 62.5	

Critical  $F_{0.05}(1,15) = 4.54$

$p(F = 33.915) < 0.05$

**Table 2**

**Comparing Tourniquet and Analogue**

Source of Variation	DF	SS	SS%	MS	VR
Methods	1	4770.94	44.09	4770.94	149.634
Residual	15	478.26	4.42	31.88	
Total	16	5249.20	48.50	328.07	
Grand Total	31	10822.09	100.00		
Grand mean = 50.34                      Tourniquet = 62.55					
Total no. of observations = 32              Analogue = 38.13					

Correlation coefficient between McGill and Tourniquet was  $r = 0.64$   
 DF = 16  
 $p = 0.01$

Correlation coefficient between Tourniquet and Analogue was  $r = 0.87$   
 DF = 16  
 $p = 0.01$

Correlation coefficient between McGill and Analogue was  $r = 0.90$   
 DF = 16  
 $p = 0.01$

Critical  $F_{0.05}(1,15) = 4.54$   
 $p(F = 149.634) < 0.05$

**Table 3**

**Comparing McGill and Analogue**

Source of Variation	DF	SS	SS%	MS	VR
Methods	1	3.13	0.03	3.13	0.065
Residual	15	721.88	6.83	48.13	
Total	16	725.00	6.86	45.31	
Grand Total	31	10571.88	100.00		
Grand mean = 38.4                      McGill - 38.8					
Total no. of observations = 32              Analogue = 38.1					

$F_{0.05}(1, 15) = 4.54$   
 $p(F = 0.065) > 0.05$

### M1 Circadian Rhythm Graph A

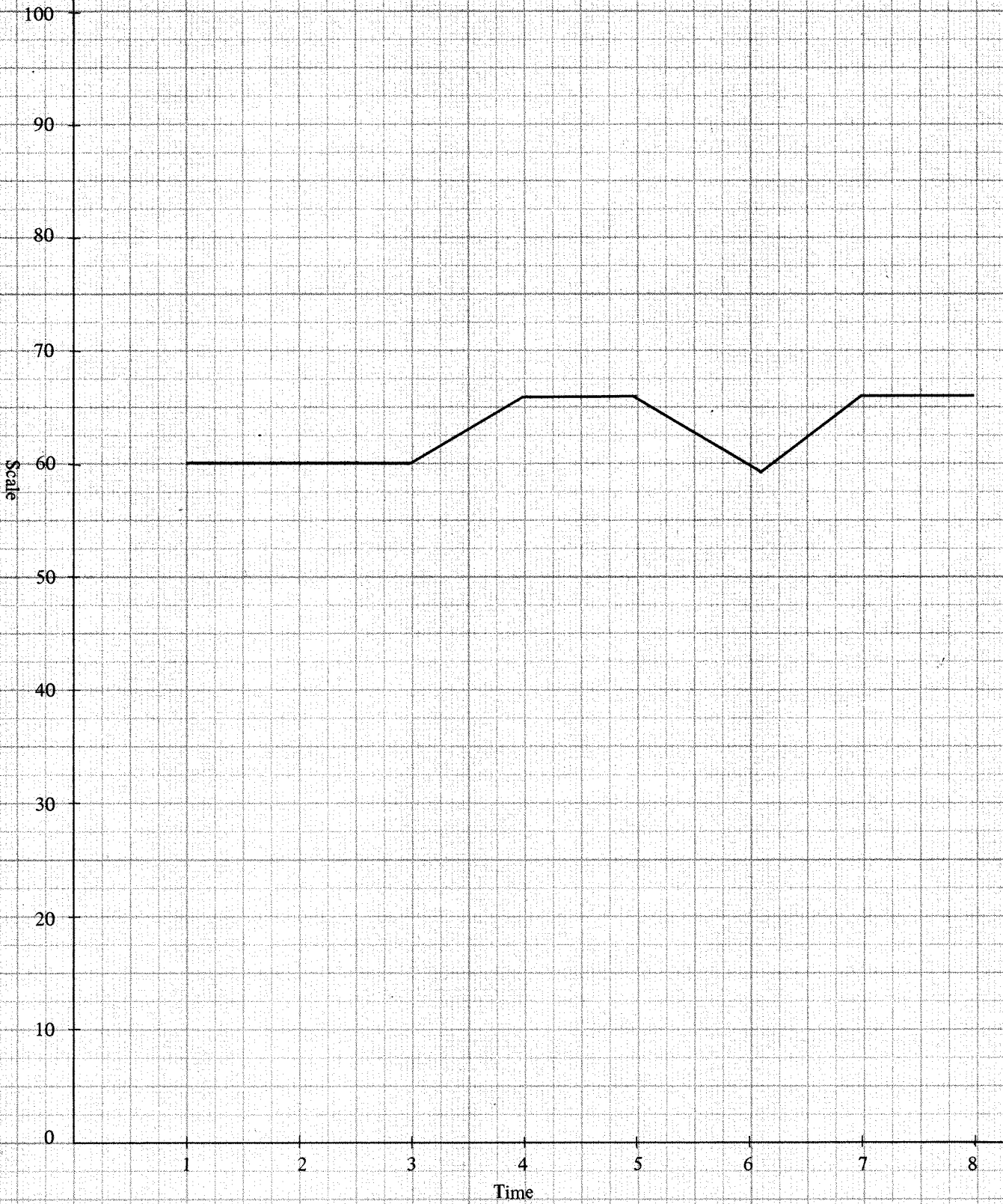

### M2 Circadian Rhythm Graph B

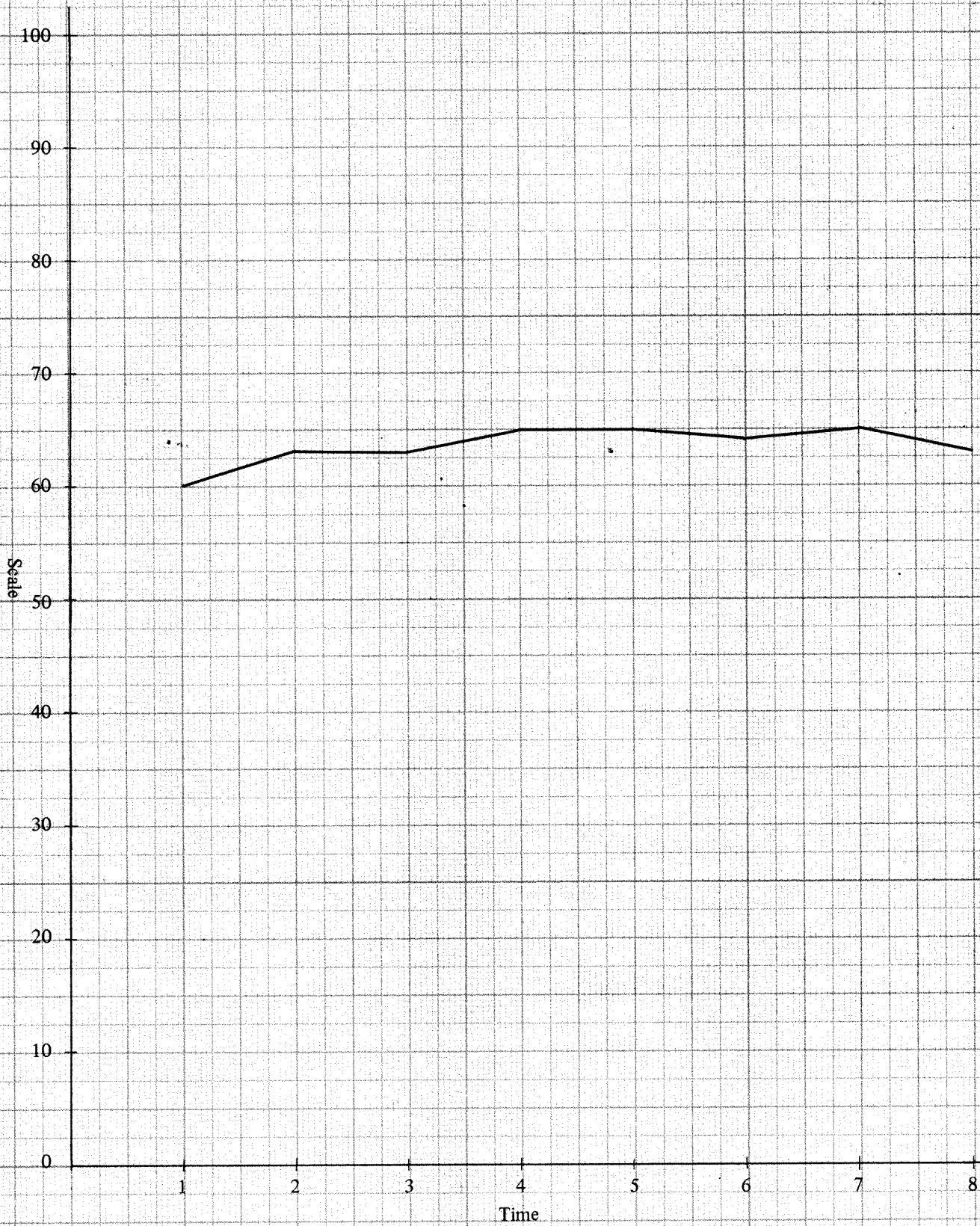

### M3 Circadian Rhythm Graph C

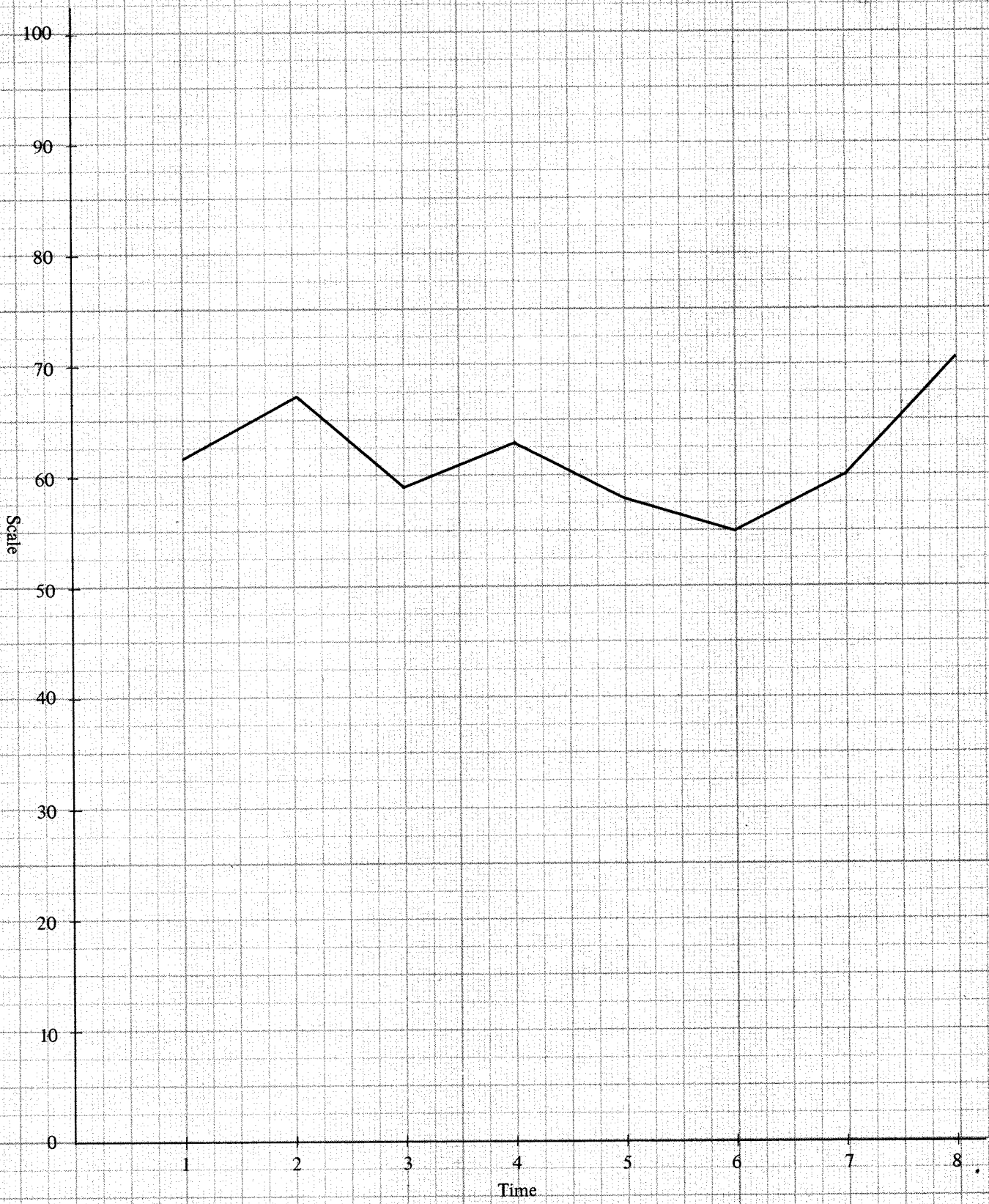



### S1 Comparability of Scale Graph D

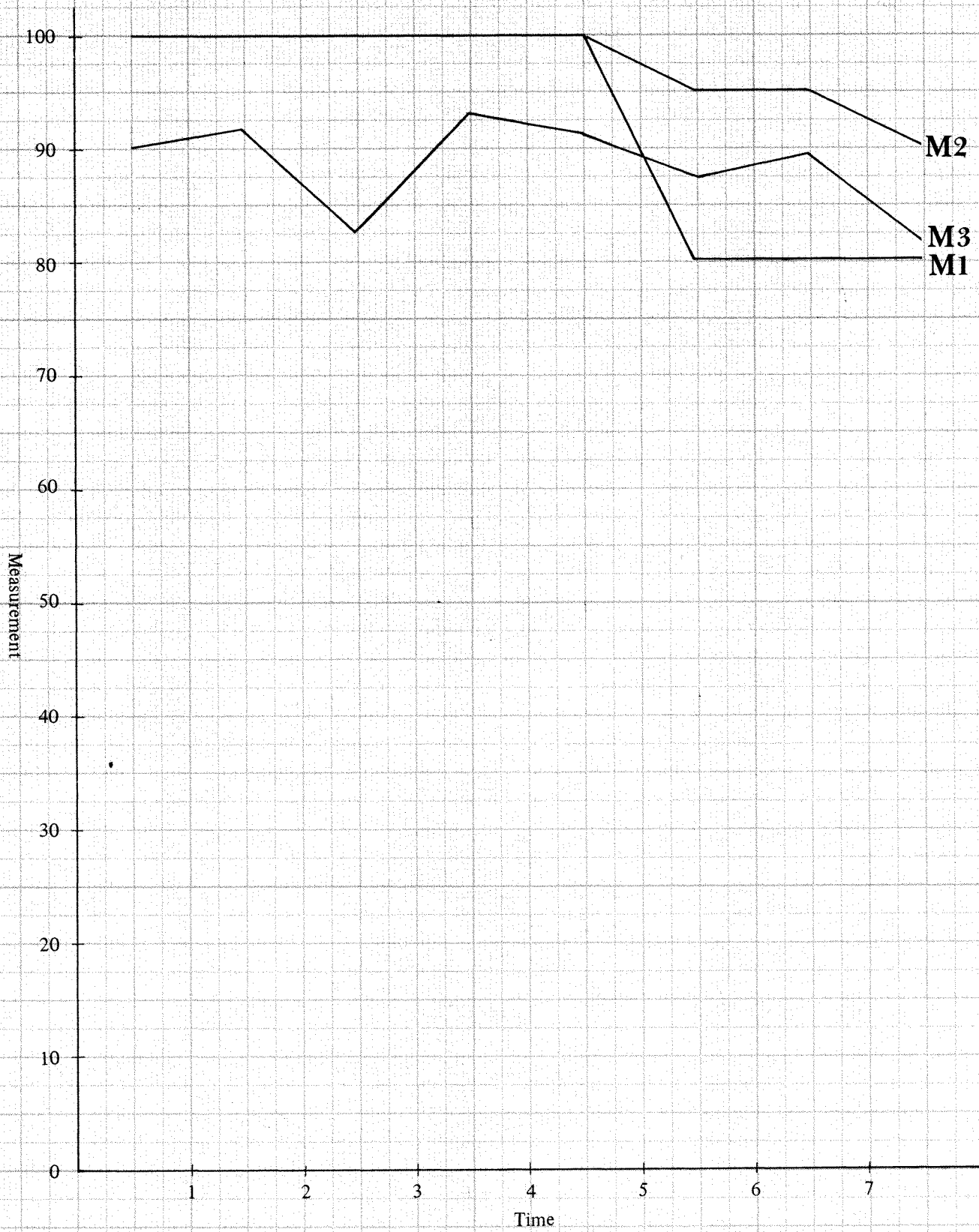

S2 Comparability of Scale Graph E

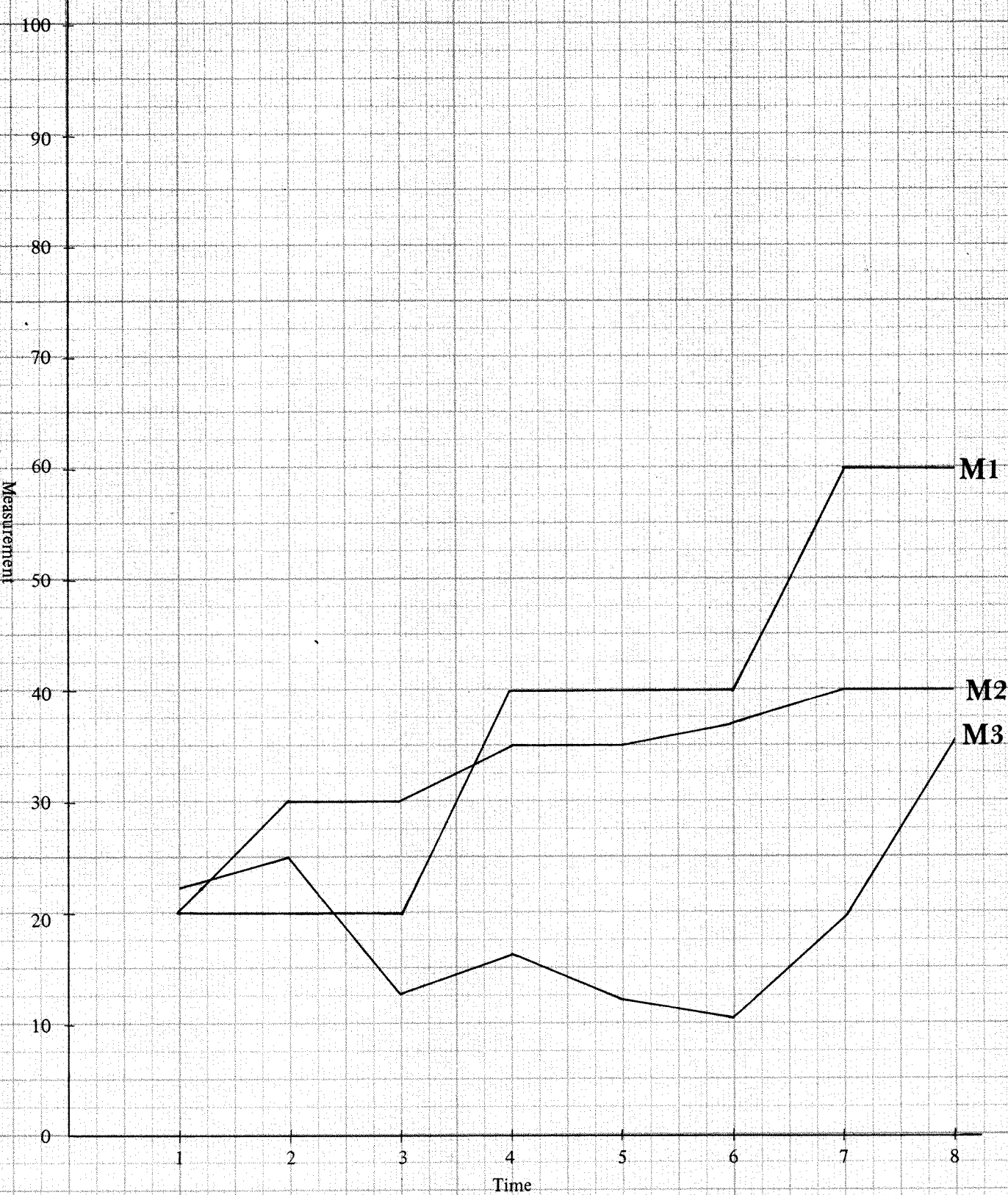

### S3 Comparability of Scale Graph F

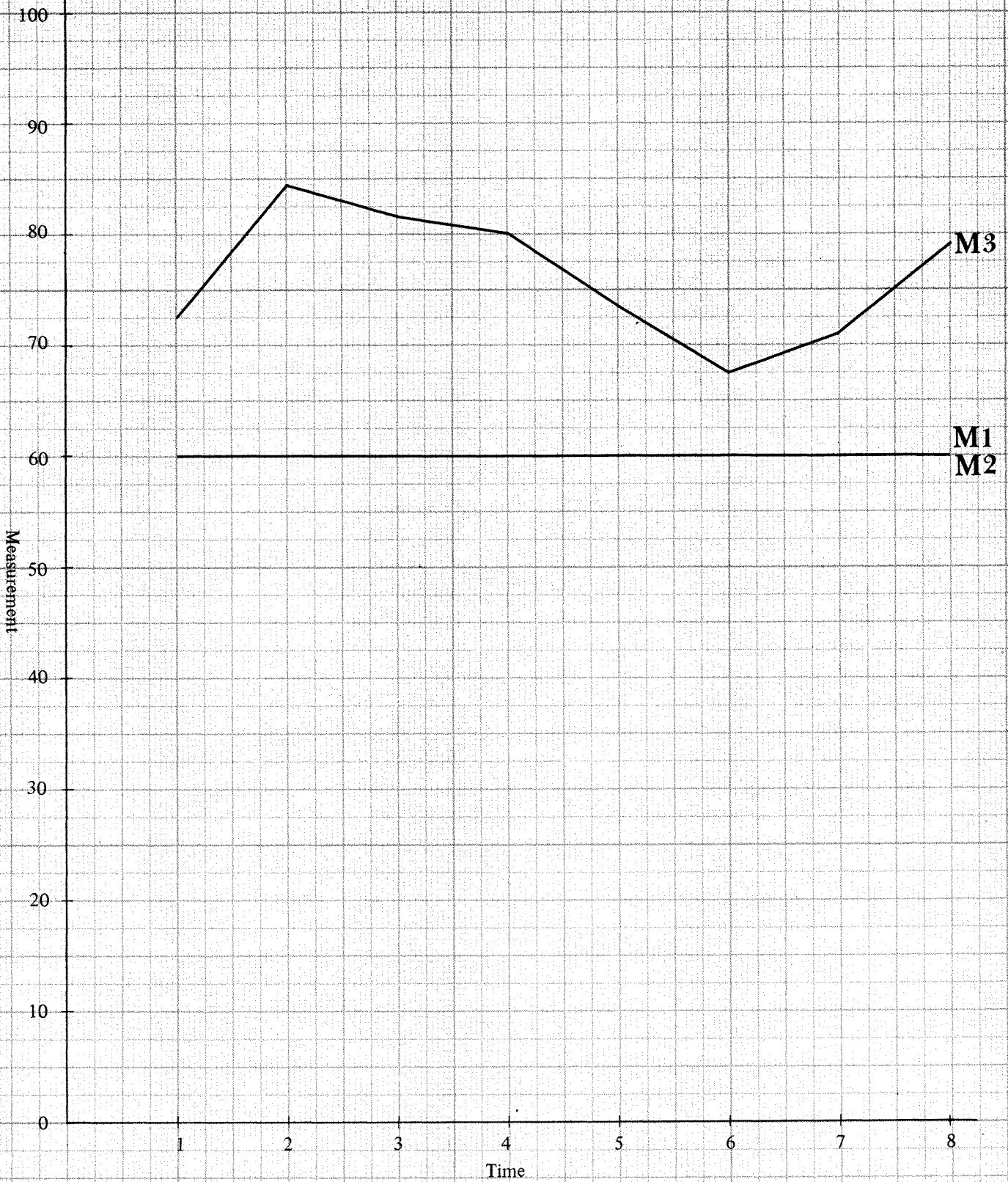



## DISCUSSION

The three methods, namely, McGill (M1 Analogue (M2) and Tourniquet (M3) were performed on 3 in-patients each taking 8 times of tests which were performed hourly. Ideally, these sessions should be spaced out, starting from the time they woke up till they retired. However, as inconvenience would be imposed on the patients as well as the hospital staff (e.g. cleaning and meal time or ward-round by doctors), hence the experimenter was only able to perform the first session at about 11 a.m.. Since the morning and evening measurements were lacking, complete detail on the diurnal variation was not obtained. Graphs A, B, and C showed the Circadian rhythms obtained from the three methods but little significant changes were indicated.

From Graphs D, E and F, the Tourniquet (M3) showed more gradual increase or decrease of pain while M1 and M2 gave more sudden fluctuation within an interval of an hour. M3 was most helpful in measuring pain intensity for the third patient (S3). He gave same ratings for M1 and M2 throughout the 8 sessions. However, M3 revealed variations in the pain level. The patient claimed incapability in indicating and differentiating pain level within short duration e.g. hours or days. He was only able to compare pain intensity on an average weekly or monthly basis. Therefore, maybe for patients who were less skillful in verbal expression, the Tourniquet could be a better tool of measurement.

Since the above data contained incomplete diurnal variation and very small subject sample, the same methods were performed on 16 out-patients.

Results obtained from One-way between subject Anova indicated that McGill was similar to Analogue but different from Tourniquet, which in turn was different from Analogue. Hence, Tourniquet was the method which was different from the other two.

Looking at the correlation coefficients McGill and Analogue were measuring very similar underlying phenomena but the data obtained by Tourniquet were of different nature from those of McGill.

Data from McGill and Analogue were of comparative value for they both involved subjective ratings. McGill gave more qualitative data when Analogue's were more quantitative and could be also viewed as objective. It contained a wider range of 0-100 and only the extreme values were described, i.e., no pain and unbearable pain. McGill, on the other hand, had only 5 numbers and yet each was accompanied by a descriptive phrase of pain. These rating scales are relative to the range of experience of that subject.

Tourniquet was an objective measure for it involved an external pain stimulus for comparison. This scale is relative to the range of pain tolerance of the subject. It yielded absolute value and obtained from reference scale. The data were quantitative and were similar in certain ways to Analogue and yet totally different from McGill. These explained

the high correlation between McGill – Analogue, and Tourniquet – Analogue and the lower correlation between Tourniquet and McGill.

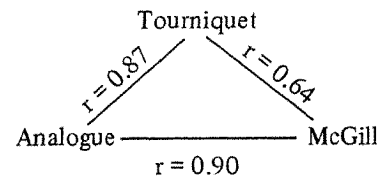

Summary table for comparing the three values

Tourniquet	Analogue	McGill
objective rating	objective - subjective rating	subject rating
quantitative data	quantitative data	qualitative data
absolute value	comparative value	comparative value
relative to range of pain tolerance of subject	relative to range of experience of subject	relative to range of experience of subject

From individual data and the means from Anova tables, it was apparent that patients consistently under-rated the McGill and Analogue and yet detected high pain level by Tourniquet. These were quite different from results obtained by Sternback (1974). In his study, "Pain Estimates" (Analogue scales) were consistently higher than Tourniquet Pain Ratio Scores to a significant degree. The interpretation was: "the Tourniquet Pain Ratio seems to measure the severity of perceived pain; the Pain Estimate seems to reflect the same, plus some communicative need". The reasons for different findings in the present study could be attributed to the difference between his patient groups and the present one. His findings were obtained from comparing pain scores of two subgroups of chronic pain patients who received intensive psychological treatment while being evaluated for possible surgical treatment. Furthermore, the pain syndromes were varied in his while the present one dealt with only AS. They were in-patients while the present group contained out-patients. Furthermore, there were the difference in the sample size (91 compared with only 16 in the present group) and time variable (single detection in the present group compared to six weekly averages).

The homogeneity of the present patient group made the finding difficult to be generalized to other chronic pain sufferers. Single testing data were insufficient but because these were out-patients, it would be difficult to detain them or frequently inviting them. So practical problems were involved

in obtaining more data. This might account partly for the lower Analogue and McGill scores. Furthermore, since all 16 patients were male and not having flare-ups there might be a lesser degree of communicative need compared to Sternback's groups.

Other reasons which could explain the underestimation in McGill and Analogue could be due to experimenter bias (Jung, 1971). Male patients facing a female experimenter would tend to show higher tolerance of pain. Hence subjective ratings were lower than those detected by objective method. There could also be the problem of conformity (Asch, 1951). As most patients claimed to be tolerating great pain, the individuals would be reluctant to admit low tolerance by indicating a high rating. Besides, complaints of pain in a hospital setting would yield little attention both from the staff as well as the peer. There was a lack of reinforcement (McConnell, 1977).

From the results, one could infer that Tourniquet was totally different from McGill and Analogue was more similar to McGill. Since Tourniquet was an objective test, maybe it was possible to suggest that it would be a more reasonable measurement of pain for AS patients.

## 10 CONCLUSION

From the results of the present research some questions were answered. In Part I, years of having the disease and emotional feelings had been investigated and relationship found. The most common feeling during pain attack was depression. The ability to obtain jobs was not governed by the educational level as might have been expected. However, pain did to a certain degree affect job satisfaction, job change and joblessness. The most common daily difficulty was getting out of bed and the waist and hip were the common locations of pain. Pain besides affecting work, also affected leisure activities, aspects of sex and marriage viewpoint. The most sought after method of pain reduction was self-medication.

Part II had shown that most patients suffered constant pain of varying intensity. Some had more pain in the morning while others at night. There was evidence for flare-ups. This constant complaint of pain led to the review of pain measurement in Part III. Differences among the three methods were found although they were correlated to some degree. The Tourniquet method appeared to be less related to the other methods than these methods were amongst themselves.

These findings gave rise to a number of further questions and a need for deeper investigation. For example, concerning self-medication it would be useful to know how effective the drug was and how great the reliance was. What other methods of pain reduction would they employ? Since their sleep was disturbed, was there a necessity in making special

preparations? Could the patient predict the duration of flare-ups? What terms would they use to describe their pain? How great was the self awareness of physical deformity? How did friends/relatives feel towards their deformity? For example, were they indifferent, sympathetic or avoiding? What was their priority in life, i.e., what was most important to them?

Since this research was for exploratory purpose, there was need to answer the above questions and gather more information. Hence a final concluding interview was conducted. With the consent of the doctor in charge, 50 invitations were sent (Appendix F) and 23 patients responded positively.

To summarize the interviews, patients admitted that analgesic drug was effective only when the pain was mild or the disease still at its initial stage. Many who had suffered pain due to AS for a long duration expressed the ineffectiveness of the drug especially during flare-ups. Nevertheless, they maintained a constant dosage especially during work or sleep. Very often with the intake they still had to endure a lot of pain. Some had great problem with sleep. Even with special arrangement like analgesic intake, hard bed with soft pad and a few pillows, they would spend most of the night trying to find a position that would be less painful and which would enable them to fall asleep for a short while before being waken again by another sharp pain. Those whose disease was stabilizing found less problem with sleep. Patients, in general found flare-ups very unpredictable in both time and duration. The duration could vary from a few days to a few weeks. Many had been hospitalized in order to have the correct drug to control the inflammation and pain.

Kotarba (1983) in discussing about age-specific responses to initial episodes of pain stated that "young adults find it very difficult to entertain the thought of suffering pain for the rest of their lives." Sternback et al. (1973) also maintained that long term concern with their pain problems resulted in emotional disturbance. The results in Part I – questionnaire, reflected such disturbance. Although AS patients may not have to suffer pain for the rest of their lives yet there is the uncertainty of the period of time they will be in pain. Hence, feelings of depression, hopelessness, frustration and irritation were frequently present during pain attacks. One extreme example of these was found in Part II where one patient failed to complete the longitudinal study due to suicidal attempt. This patient also attended the concluding interview. He emphasized having poor self-image and a constant awareness of his deformity. He feared passing windows and mirrors which would reflect his deformed body. Another patient, a chef, expressed similar feeling and stated "to die is than better to live" (生不如死) a few others admitted of having entertained the thought of suicide.

Apart from emotional disturbance somatization was also detected. One patient complained of dis-

comfort and pain in various parts of the body. He claimed to be suffering from asthma, intestinal problem, ulcer etc. and after examined by the various medical departments, was finally referred to the Psychiatric Unit in Queen Mary Hospital. He complained of the lack of comfort and understanding from his brother and sister-in-law whom he was staying with. This might reflect a poor knowledge about the disease for many of the patients' relatives often equate it with "rheumatism". It was generally observed and admitted by patients during the interview that the more adapted and less depressed ones had understanding relative or friends, for example the patient who was accompanied by his wife in the preliminary interview. This suggests the need for supportive systems e.g. relative, peers, self-help club etc. However, support should be in the form of encouragement towards "well behaviour" (Fordyce, 1976) rather than reinforcement of illness behaviour. Well behaviour, like illness behaviour, is strongly influenced, not only by physical changes, but by environmental support. For example, pain has been shown to contrive at high levels when the patient is rewarded for concentrating on and discussing pain (McConnell, 1977). The reward in this case consisted of sympathy and attention on the part of relatives and friends. Thus, although there is a need for support systems, these have to be carefully structured and informed about possible detrimental effects. It is unfortunately true that, for practical reasons, the amount of attention paid by doctors to patient is directly related to their degree of illness. This can have very serious effect in a hospital environment where attention by doctors is highly valued by patients (McConnell, 1977). When the patient complained of pain, relative or friends from self-help club should also encourage exercise rather than asking the patient to lie down and take some analgesics. Drug and attention should not be given together for this reinforces pain behaviour and works to the patient's detriment. The self-help club with the help of physiotherapist should emphasize the advantage of exercise or hold meetings to demonstrate and periodically encourage and check each other's progress.

Furthermore, the self-help club members, physicians, psychologists and relatives should be sensitive enough to detect those who are psychologically at risk so that appropriate intervention can take place before it is too late.

Another important factor which causes depression and feeling of inferiority is employment. For those who were employed, they felt that besides being financially independent, there was less avoidance and discrimination from relatives and friends for there was no fear of money borrowing. Very often, the jobless ones, if not visibly deformed would be treated as being lazy and despised. As Part I had shown, pain affected work and emotion, so there is the need to investigate further into the possible areas of help. For example, one patient

pointed out that in applying for Disability Allowance, the patient must be certified as handicapped. However, in his case, he was not visibly or grossly deformed (Only needed a stick to assist in moving along stairs). So his application was turned down and yet when applying for work, he was discriminated by employers for not able to function "normally". So besides suffering from pain and disease he had financial problem. In view of this, proposals may have to be made concerning a change in the criteria for obtaining Disability Allowance, especially among AS patients. However, in order to make this proposal valid, information should be gathered as to how great the percentage of patients have been affected, the number of AS patients being refused of application and the consequence of the refusal both financially and psychologically.

Pain and AS creating problems in sex and marriage were further shown during the interviews. One female patient had the disease after giving birth to her first son. She admitted frequent experience of pain in the joints during intercourse. She endured it in order to keep her marriage as her husband had very little knowledge about the disease and not sympathetic enough at first. Relatives doubted her explanation and suggested she could be suffering from venereal disease. They often refused to help her during her flare-ups. Another male patient disclosed the fact that his wife was divorcing him. The wife was rather active and young and since he could not participate often in our-door activities, she was dissatisfied. They had a son and he worried if he was able to take care of him when his condition worsened. Some patients were very conscious of their physical deformity and appearance so they shied away from new acquaintances. Their social circle became smaller and smaller. Many had to give up their former hobbies. The pain not only caused problem in their daily activities but also their leisure pursuit. The limited social interaction together with their own doubts and fear about hereditary factor or financial stability, resulted in a gloomy opinion about marriage. Some were too preoccupied with their pain and disease to think about marriage. So AS and the resulting pain had a definite effect on work, activities, sex and marriage.

All interviewees claimed to have experienced sleep disturbance due to pain. Special sleeping arrangements had to be made, e.g., bed with wooden board and soft pad, a few pillows under the small of the back or hip area and intake of analgesic. However, during flare-ups, sometimes even with all the above arrangements, sleep would still be disturbed. Furthermore, if the flare-up did not happen on the clinic day (every Thursday), they would have to consult private practitioners and receive injection to reduce the pain. Apart from the above situation, they rarely seek advice from other doctors. Since the referral to the clinic at DKCH, they had stopped "doctor hopping" (Kotarba, 1983). Their coping strategies, besides self-medication and

returning to the clinic, included exercises, work and occasional talking and exchanging experience with peers.

When asked to describe about their pain, the terms they used were similar to those mentioned in Part III. Hence, it further justified that the 102 pain terms of the McGill Pain Questionnaire was inappropriate for Chinese subjects. Concerning flare-ups, all patients admitted that the duration was unpredictable and varied from a few days to a few weeks. Their favourite pain reduction method was self-medication. Although many had the realization about the minimal effectiveness of the drug but continued the intake for fear of pain attack, especially during work and sleep. They took analgesics as a preventative measure. So it would be helpful if physician could impose a more realistic viewpoint about analgesic among the patients. They should investigate if there was a true need for the drug and prevent drug abuse. The results from Part III of this research may be helpful in measuring the pain intensity during examination. Rather than a rating of mild, moderate or severe, the patient can be given the Tourniquet test and indication of increase or decrease in comparing with the previous record can aid in the prescription of analgesic and possibly discourage illness or pain behaviour.

All the patients expressed an unanimous wish for the pain to dissipate completely and health regained. Many worried about the final outcome of the disease and the degree of deformity. The new patients attending the clinic were frightened by the severe degree of deformity found in some "old" patients. They need more knowledge about the disease. Maybe the self-help club can organize lectures and talks by experts.

A program like the operant approach one described by Fordyce (1976) would be premature at this stage of the study at DKCH. There would be administrative as well as staffing problem. The doctors at DKCH are all involved with other government hospitals and clinics and university teaching. They can only afford one clinic session per week and occasional ward-round for the few AS in-patients. However it would be possible for the physicians to be more aware of the type of conditioning contingencies that they set up. The reinforcement should be a positive one, ie, encouraging well behaviour and discouraging illness behaviour and dissociated pain medication from pain behaviour. Pain medication was given in a noncontingent manner in the Fordyce program. Eventually, medication is faded and replaced by the smallest amount of placebo. Exercise was the core of the program and inclusion of spouse or significant other was essential.

Although a fully launched program like Fordyce's would not be possible yet physicians should discourage the reliance on drug and prescribed only under necessity. Maybe with the help of the Tourniquet test they could be able to save patients

from the potentially damaging effects of their own judgement on pain intensity and if they used drug as a preventative measure. It would be within the ability of the team at DKCH to encourage well behaviour, possibly with the co-operation of patient's relatives.

To conclude, the present research has answered some questions concerning how patients perceived pain and how pain affected their lives. Diurnal variation and incidents of flare-ups had been investigated and the methods of measuring pain had been reviewed. A few recommendations were made. For example, further study on the jobless situation and evidence of hardship caused by the restriction and criteria when applying for Disability Allowance should be carried out in order to improve and alleviate their financial problem. There is a need for detecting those who were psychologically at risk as depression and other negative feelings prevailed during pain attack. Timely intervention and referral would be desirable. This detection could be performed by physicians, psychologists, relatives and peers in the self-help club. Many useful functions can be carried out by the club. It can encourage exercise, provide useful talks which can increase knowledge about AS. It can invite and obtain help from psychologists for those who may need marriage or genetic counselling. The members should provide each other with support towards well behaviour. The "older" and more deformed members should refrain from emphasizing their suffering and deformity which may create fear and uncertainty among the new comers. Pain should not be the main topic of conversation but rather knowledge about benefits of exercises or other coping strategies should be shared. Involvement of spouse or relatives should be encouraged so that more support can be rendered. The excessive or unnecessary intake of analgesic should be discouraged by peers and relatives. Physicians, by using the Tourniquet test may be able to obtain a more objective measurement of pain. Appropriate prescription and prevention of drug abuse may be possible.

There are many questions to which the present research fails to provide empirically valid answers. It attempts to look at many areas in the lives of AS patients, for example, work, leisure, sex, marriage, emotion, daily activities, locations of pain and coping strategies. Furthermore, it seeks to understand diurnal variation and flare-ups and review methods of measuring pain. Because of this wide coverage, the data are not sufficient to provide any cause and effect analysis and only superficial understanding of the many problems has been possible. The questionnaire has not made any in-depth study in any of the areas. The 3-week longitudinal study can only provide evidence for flare-ups and fails to show more detailed variation in the course of the disease. A longer period will be more desirable. There was a problem with the charts of confounding between physical deterioration

and analgesic intake. In many cases, these two may have cancelled each other out. However, the charts do indicate the change in actual pain levels over time, and the variation in pain over this period of time. Even with analgesics, it was still possible to see evidence for flare-ups, although it could be argued that these are psychological (or psychosomatic) in origin. There is no evidence in the present study to determine the causal or even contributory factors. The analgesic intake on the charts as well as verbal reports during the interviews can only serve as indication but not empirical proof of drug use. The comparison of methods in Part III shows that the methods are different but fails to claim which method is best and most accurate in measuring pain.

However, based on the findings future research can be conducted. Psychologist, imitating the McGill Pain Questionnaire format, may be able to gather enough pain terms from Chinese patients of different pain syndromes to design one that suits Chinese culture. The doctor in charge of the study at DKCH can test the actual effectiveness of analgesics. There

should be some investigation of the suggestion from the interviews that analgesic drugs are firstly, not particularly effective, and secondly, taken as a preventative measure by patients. This suggests that perhaps more analgesics are taken than are strictly necessary, thus possibly leading to the lack of effectiveness of the drugs. With sufficient staff and time maybe a program similar to Fordyce's can be launched. The self-help club with the help of physiotherapist and psychologists can investigate the effectiveness of exercise and provide better coping strategies. They can study more thoroughly the effect of pain on specific aspects, for example, help the unmarried patients to view marriage and hereditary factor in a more positive way. They can collect evidence of difficulties in applying for Disability Allowance so as to substantiate their claim to change the criteria for application. The self-help club working in close association with the team at DKCH may provide better solution and help to the AS patients through future research.

## REFERENCES:

1. *Ankylosing Spondylitis: A handbook for patients, published by the Arthritis and Rheumatism Council, London.*
2. Asch, S.E., *Effects of group pressure upon the mdofication and distortion of judgement. In H. Guetzhaw (Ed.), Groups, leadership, and men. Pittsburgh: Carnegie, 19851.*
3. Bakal, D.A. *Psychology and Medicine: Psychological dimensions of health and sickness. N.Y.: Springer, 1979, 139-171.*
4. Beecher, H.K. *Relationship of significance of would to the pain experienced. Journal of the American Medical Association, 1956, 161, 1609-1613.*
5. Bone, M.R. *Pain, its nature, analysis and treatment, Churchill Livingston, Edinburg, 1978.*
6. Buchanan, J. *The Social and Economic Disadvantages of Ankylosing Spondylitis. The National Ankylosing Spondylitis Society Symposium 1981.*
7. Calabro, J.J. & Mody, M.E. *Management of Ankylosing Spondylitis. American Journal of Occupational Therapy, 1965, 19, 255.*
8. Chamberlain, M.D. *Socio-domestic and psychological factors in management. In Ankylosing Spondylitis. John Moll (ed.), Churchill Livingston, 1980.*
9. Fordyce, W.E. *Behavioral emthods for chronic pain and illness. St. Luis: C.V. Mosby, 1976.*
10. Jung, J. *The Experimenter's Dilemma. NY: Harper and Row, 1971.*
11. Kerlinger, F.N. *Behavioral Research a Conceptual approach, Holt, Rinehart and Winston, U.S.A. 1979.*
12. Kleinman, A. & Tsung-Yi Lin. *Normal and abnormal behaviour in Chinese culture. Dordrecth, Rudel, 1981.*
13. Kotarba, J.A. *Chronic Pain: Its social dimensions, Sage publications, 1983.*
14. McConnell, J.V. *Understanding Human Behaviour; an Introduction to Psychology. NY: Holt, Rinehart and Winston, 1977.*
15. Melzack, R. *The McGill Pain questionnaire, Pain, 1975, 1, 279-299.*
16. Norton, J.C. *Introduction to Medical Psychology. N.Y.: Free Press, 1982, 118-135.*
17. Prokop, C.K. *Medical Psychology: Contributions to Behavioral Medicine. N.Y.: Academic Press, 1981, 91-117.*
18. Ray, C. *Pain in Psychology and Medincine, David Griffiths (ed.), London. British Psychological Society and MacMillan Press, 1981, 349-364.*
19. Sternback, R.A. *Pain Patients: traits and treatment. Academic press, 1974.*
20. Sternback, R.A., Murphy, R.W., Timmermans, G., Greenhoot, J.H. and Akeson, W.H. *Measuring the Severity of Clinical Pain. Advances in Neurology. Vol. 4, Raven Press, N.Y. 1974.*
21. Sternback, R.A. *Clinical aspects of pain. In R.A. Sternback (ed.), The Psychology of Pain, N.Y.: Raven Press, 1978.*
22. Uddenberg, N. *Childbirth pain, In Osborne D.J., Gruneberg, M.M. and Eiser, J.R. (eds.), Research in psychology and medicine (Vol. 1). Academic press, London 1979.*
23. Weinman, J., *An outline of Psychology as applied to Medicine. Bristol Wright, 1981.*
24. Weisenberg, M. *Understanding Pain Phenomena. In Contributions to Medical Psychology. Vol. 2, S. Rachman (ed.), Pergumon Press, 1980.*

## 請盡量填寫此問卷，多謝合作！

1. 有了這病多久？———年
2. 你有沒有讓你的朋友知道你患了這種病？  
 所有的朋友都知道  小部份的朋友知道  \_\_\_\_\_ 個  
 沒有朋友知道
3. 有沒有和家人談及你的病痛呢？ 常常談及   
 有時談及   
 從來不談
4. 每當有痛時，你會不會有下面的感覺呢？

	常常會覺	有時會覺	從來不會覺
絕望			
沮喪			
頓挫			
激怒			
抵抗			
不在乎			

5. 你的教育程度是：小學  中學  大學   
 現時有沒有職業呢？ 有  無   
 （請答第 6 題） （請答第 7 題）
6. 如果有做工，性質是： 經常要走動，非常少坐下   
 有時走動，有時坐下   
 長時間坐着工作

你的上司或僱主知道你的病情嗎？ 知道   
 不知道

對現在的工作滿意否？ 滿意  不滿意

為什麼不滿意？ \_\_\_\_\_

為什麼滿意？ \_\_\_\_\_

做了多久？ \_\_\_\_\_ 年 \_\_\_\_\_ 月

每月入息多少？ \_\_\_\_\_ 元

7. 如果沒有做工，是否因有這病而沒法做？ 是  否   
 每月入息多少？ 元  
 來源： 家人  公共援助  其他
8. 自從病後有多少次要轉換工作？ 次  
 原因是：工作時因痛而要停止   
 僱主認為我不適合   
 其他原因
9. 在日常生活中遇有困難的：  
 從床上起來  洗面刷牙  穿衣   
 著鞋  上廁所  洗澡
10. 平時多數用那種交通工具？  
 巴士  小巴  地鐵  的士
11. 遇到的困難是： 人太多，被破撞  梯級常高   
 很難企穩  其他困難
12. 痛的部位多數在什麼地方？  
 脚  盤骨  腰  背  頸
13. 工餘或假日多作何種活動？ \_\_\_\_\_  
 有沒有因為病了而要改變以前的工餘活動？ 有  沒有   
 以前的活動多數是 \_\_\_\_\_  
 為什麼要改變呢？ \_\_\_\_\_
14. 每當有痛，要立即停止： 工作  日常生活動作  娛樂  其他
15. 你是： 已婚  未婚  離婚   
 如果已婚或離婚：性生活有沒有因痛而受阻？ 有  沒有   
 如果未婚：因為這病已放棄結婚的念頭   
 未決定會否結婚，但有疑問   
 會結婚，不過未有對象
16. 當你痛時，你會用何種方法去減少痛楚？  
 看醫生  自服止痛藥  運動   
 其他方法  例如 \_\_\_\_\_



## APPENDIX B

Please fill in this questionnaire. Thank you!

1. How long have you been ill? \_\_\_\_\_ years
2. Do you let your friends know about your illness?  
All friends know  some friends know  (no.) \_\_\_\_\_ no friends know
3. Do you talk to your family members about your illness? always   
sometimes   
never

4. When you are in pain, do you have the following feeling?

	always	sometimes	never
hopeless			
depressed			
frustrated			
irritated			
resistant			
indifferent			

5. Your educational level: primary  secondary  tertiary   
Do you have a job at present? yes  no

6. If you are working, do you: always walk around and seldom sit?   
sometimes walk and sometimes sit?   
always sitting down?   
Does your boss know about your illness? yes  no   
Are you satisfied with your present job? satisfied   
not satisfied

Why are you satisfied? \_\_\_\_\_

Why are you not satisfied? \_\_\_\_\_

How long have you been working at the present job? \_\_\_\_\_ years \_\_\_\_\_ months

Average income per month is \_\_\_\_\_

7. Is it because of the disease that you are without job? yes  no   
monthly income: \_\_\_\_\_  
sources of income: relatives  public assistance  others

8. How many times have you changed jobs after you got ill? \_\_\_\_\_  
Reasons for change of jobs: pain during working   
boss considered me unfit   
other reasons

9. Difficulties found in daily activities:  
getting out of bed  cleaning face and teeth  dressing   
putting on shoes  going to toilet  bathing

10. What kind of transportation do you usually use?  
 bus  mini-bus  MTR  taxi/car
11. Difficulties found during travelling:  
 too many people, being bumped  stairs too high   
 difficult to stand still  other problems
12. Location of pain:  
 leg  hip  waist  back  neck
13. What leisure activities do you do?  
 Have the activities been changed after you got ill? yes  no   
 Previous activities were:  
 Why are they changed?
14. When you are in pain, you have to stop doing:  
 working  daily activities  leisure activities  others
15. You are: married  single  divorced   
 If married or divorced, have your sexual activities ever being hindered due to pain? yes  no   
 If you are single: because of the disease you have given up marriage   
 have not decided but have doubts   
 will marry
16. When you are in pain, what kind of pain reducing methods would you use?  
 see a doctor  self-medication  exercises   
 others

## APPENDIX C

這研究是針對「痛」這樣東西，從而對病人多些了解和幫助，故此請參加為期三週的填表運動。

請注意下面各點：

1. 把每天早上剛睡醒時所感到的痛楚，用筆表示在圖表上，○表示無痛，100 代表沒法忍受的痛，而請在適當的地方加上「X」符號。

如果在半夜痛醒而要服止痛藥，請把中間距離的時間和藥丸的數目填上。

2. 每夜臨睡前亦作同樣填寫。

3. 請盡量依時填表，但如果萬一漏了一次，請不要中止，把其餘的繼續下去。  
每星期填完，請用回郵信封寄回填好的表格給何醫生。

謝謝你的合作！如有任何問題，請把名字告訴接線生，何醫生會和你聯絡。

茲付上表格 3 份，信封 3 個，及筆 1 枝。

例：            0 = 無痛  
                  100 = 沒法忍受的痛            請加上「X」符號

星 期 一	早上 剛睡醒		服了藥 <u>0</u> 小時 <u>  </u> 分 止痛丸 <u>0</u> 粒
	晚上 臨睡前		服了藥 <u>1</u> 小時 <u>15</u> 分 止痛丸 <u>2</u> 粒

APPENDIX D

第一個星期

0 =無痛

100=沒法忍受的痛

1.請加上「X」符號

2.服了藥多久？

3.服了多少藥？

星期五	早上 剛睡醒	0 10 20 30 40 50 60 70 80 90 100	服了藥 ___ 小時 ___ 分 止痛丸 ___ 粒
	晚上 臨睡前	0 10 20 30 40 50 60 70 80 90 100	服了藥 ___ 小時 ___ 分 止痛丸 ___ 粒
星期六	早上 剛睡醒	0 10 20 30 40 50 60 70 80 90 100	服了藥 ___ 小時 ___ 分 止痛丸 ___ 粒
	晚上 臨睡前	0 10 20 30 40 50 60 70 80 90 100	服了藥 ___ 小時 ___ 分 止痛丸 ___ 粒
星期日	早上 剛睡醒	0 10 20 30 40 50 60 70 80 90 100	服了藥 ___ 小時 ___ 分 止痛丸 ___ 粒
	晚上 臨睡前	0 10 20 30 40 50 60 70 80 90 100	服了藥 ___ 小時 ___ 分 止痛丸 ___ 粒
星期一	早上 剛睡醒	0 10 20 30 40 50 60 70 80 90 100	服了藥 ___ 小時 ___ 分 止痛丸 ___ 粒
	晚上 臨睡前	0 10 20 30 40 50 60 70 80 90 100	服了藥 ___ 小時 ___ 分 止痛丸 ___ 粒
星期二	早上 剛睡醒	0 10 20 30 40 50 60 70 80 90 100	服了藥 ___ 小時 ___ 分 止痛丸 ___ 粒
	晚上 臨睡前	0 10 20 30 40 50 60 70 80 90 100	服了藥 ___ 小時 ___ 分 止痛丸 ___ 粒
星期三	早上 剛睡醒	0 10 20 30 40 50 60 70 80 90 100	服了藥 ___ 小時 ___ 分 止痛丸 ___ 粒
	晚上 臨睡前	0 10 20 30 40 50 60 70 80 90 100	服了藥 ___ 小時 ___ 分 止痛丸 ___ 粒
星期四	早上 剛睡醒	0 10 20 30 40 50 60 70 80 90 100	服了藥 ___ 小時 ___ 分 止痛丸 ___ 粒
	晚上 臨睡前	0 10 20 30 40 50 60 70 80 90 100	服了藥 ___ 小時 ___ 分 止痛丸 ___ 粒

## APPENDIX E

下面五格內的字表示不同程度的痛楚，最輕微的是 1，而 5 則表示最厲害。

1	2	3	4	5
小小痛	不舒服的痛	苦惱的痛	可怕的痛	劇烈的痛

請選擇上面任何一個數字去形容：

- 你現在的痛
- 你一生中最痛的牙痛
- 你一生中最痛的頭痛
- 你一生中最痛的胃痛

現在請你把你的痛用數目去代表，下面 0 - 100 中那個數目可以表示你現在感覺到的痛呢？0 代表沒有痛，100 代表無法忍受的痛，請在適當地方加上「X」符號。

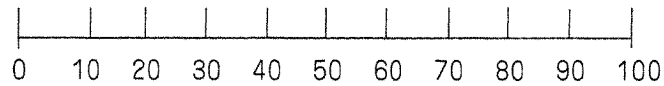

敬 啓 者

台端對回答強直性脊椎炎問卷之合作及關懷，本人極表感謝。此研究對治療該病有一定重要幫助，日後必然向病者及有關人仕詳述。

爲更加進一步明瞭此病之痛楚對病者各方面之影響及作一歸納性之結論。許太與本人將於十月十六日星期日（上午十時至一時）安排各位到大口環根德公爵夫人兒童醫院門診部面討。懇請台端屆時到臨。如約見時間不方便，可致電強脊傷健社會長陳致祥（5-526338  
5-538488  
5-539382）再另約見。此至

君

祝好！

何醫生  
上

# 強直性脊椎炎患者生活狀況調查問卷

姓名： \_\_\_\_\_ | |

性別： \_\_\_\_\_ | |

年齡： \_\_\_\_\_ | |

出生日期： \_\_\_\_\_ 出生日期 | |

## (一) 病 歷

1. 最初起病時年齡： \_\_\_\_\_ | |

2. 你所感受到的痛楚是：（請圈適當答案）  
輕微 | | 中度 | | 嚴重 | | 完全不可以忍受 | | | |

3. 你病時你行動限制的程度是： 對  
輕微 | | 中度 | | 嚴重 | | 完全不可以忍受 | | | |

## (二) 家 庭

1. 婚姻狀況：  
未婚 | | 已婚 | | 分居 | | 離婚 | | 喪偶 | | | |  
如已婚，子女人數： \_\_\_\_\_ | |

2. 你覺得家人對你的病有多少認識：  
深切認識 | | 有些少認識 | | 沒有認識 | | | |  
有些少誤解 | | 極度誤解 | |

3. 你覺得家人對你有多少體諒：  
非常體諒 | | 有些少體諒 | | 沒有反應 | | | |  
有些少不體諒 | | 完全不體諒 | |

4. 你覺得你的病對你和家人的相處有什麼影响：  
非常良好影响（例：促進家人互相關心） | | 12  
有些少良好影响 | | 沒有不良影响 | | 有些少不良影响  
極度不良影响（例：增加家庭磨擦） | |

## (三) 教育程度：

從未受教育 | | 小學 | | 中學 | | 大專或以上 | | | | 13

#### (四) 工作

1. 職業： \_\_\_\_\_  14
2. 入息： \_\_\_\_\_  15
3. 工作狀況：  16  
全時間  兼職  失業  退休
6. 收入來源：  17  
生意盈利  薪金  積蓄  公共援助   
傷殘津貼  家人及親屬提供
5. 你在現在的職位任職多久： \_\_\_\_\_  18
6. 你得到到最高的薪酬： \_\_\_\_\_ 曾得  19  
那時的職業是什麼： \_\_\_\_\_  20  
那時你的年齡是： \_\_\_\_\_  21
7. 你有沒有因病而更換工作： 有  沒有   22
8. 你有沒有因病而被僱主解僱或勸喻停職： 有  沒有   23
9. 你有沒有因病而被拒絕一份新的工作： 有  沒有   24
10. 你有沒有因病而和其他同事引起磨擦： 有  沒有   25
11. 你有沒有到展能就業組登記： 有  沒有   26  
該署有沒有替你找到工作： 有  沒有   27  
等候時間有多久： \_\_\_\_\_  28
12. 在最近十二個月內，你會因你的病請過多少天病假： \_\_\_\_\_天  29
13. 你覺得你的僱主給予你多少自主權去安排你的工作來適應你病的情況：  
好多  些少  沒有   30
14. 你覺得你的病對你事業發展有什麼影響：  
有好大幫助  有幫助  沒有影響   31  
有妨礙  有好大妨礙

#### (五) 居住環境

1. 1. 住所類別：  32  
自置樓宇  租賃樓宇  公共屋邨  租賃房間   
木屋  宿舍  床位
2. 與何人同住：  33  
自己一人  父母  父母及兄弟姊妹  配偶   
子女  配偶及子女  其他親屬  朋友



3. 住所面積：\_\_\_\_\_ | | 34
4. 同住人數：\_\_\_\_\_ | | 35
5. 你有沒有被恩恤遷置： 有 | | 沒有 | | | 36
6. 有沒有電梯到達： 有 | | 沒有 | | 不適用 | | | 37
7. 住所附近的公共設施（例：銀行、郵局、街市、車站）是否方便：  
是 | | 否 | | | 38

(六) 交通 請在(甲)部及(乙)部 ✓ 上適合的答案：

		(甲)			(乙)		
		經常用	有時用	沒有用	使用時 有困難		
常用的交通工具：	巴士						39
	小巴						40
	地鐵						41
	電車						42
	的士						43
	私家車						44
	復康巴士						45
	其他						46

(七) 平常生活情況

請在下列活動中，在(甲)部及(乙)部 ✓ 上適當的答案：

		(甲)			(乙)		
		經常	間中	沒有	滿意 現狀	想有改 改變	
1.	幫手做家务						47
2.	探訪朋友						48
3.	探訪親戚						49
4.	自己照顧自己(起居、飲食、衣著)						50
5.	幫手預算屋企開支						51
6.	記得按時候做些重要的事(準時返工，約了人記得去，揀細路返學，返醫院覆診)						52
7.	同屋企人和睦相處						53
8.	幫屋企人買嘢(例：買餸，家庭加品什物等)						54

9	同隔離鄰舍和睹相處	<input type="checkbox"/>	<input type="checkbox"/>	<input type="checkbox"/>	<input type="checkbox"/>	<input type="checkbox"/>	<input type="checkbox"/>	55
10	幫手照顧同埋管教細蚊仔	<input type="checkbox"/>	<input type="checkbox"/>	<input type="checkbox"/>	<input type="checkbox"/>	<input type="checkbox"/>	<input type="checkbox"/>	56
11	去拜神，守禮拜，望彌撒	<input type="checkbox"/>	<input type="checkbox"/>	<input type="checkbox"/>	<input type="checkbox"/>	<input type="checkbox"/>	<input type="checkbox"/>	57
12	返工或返學	<input type="checkbox"/>	<input type="checkbox"/>	<input type="checkbox"/>	<input type="checkbox"/>	<input type="checkbox"/>	<input type="checkbox"/>	58
13	拎錢返屋企	<input type="checkbox"/>	<input type="checkbox"/>	<input type="checkbox"/>	<input type="checkbox"/>	<input type="checkbox"/>	<input type="checkbox"/>	59
14	培養自己的興趣及嗜好 (例：種花，養魚，養雀，做手工)	<input type="checkbox"/>	<input type="checkbox"/>	<input type="checkbox"/>	<input type="checkbox"/>	<input type="checkbox"/>	<input type="checkbox"/>	60

### (八) 閒暇活動

請在下列活動中，在(甲)部及(乙)部  上適合的答案：

	(甲)			(乙)			
	經常	間中	沒有	希望多 做些	希望少 做些		
15 係屋企做工夫(例：修補傢具，清潔環境)	<input type="checkbox"/>	<input type="checkbox"/>	<input type="checkbox"/>	<input type="checkbox"/>	<input type="checkbox"/>	<input type="checkbox"/>	61
16 做些自己嗜好嘅嘢(例：淋花，餵狗，餵雀仔，做手工)	<input type="checkbox"/>	<input type="checkbox"/>	<input type="checkbox"/>	<input type="checkbox"/>	<input type="checkbox"/>	<input type="checkbox"/>	62
17 聽收音機	<input type="checkbox"/>	<input type="checkbox"/>	<input type="checkbox"/>	<input type="checkbox"/>	<input type="checkbox"/>	<input type="checkbox"/>	63
18. 睇電視	<input type="checkbox"/>	<input type="checkbox"/>	<input type="checkbox"/>	<input type="checkbox"/>	<input type="checkbox"/>	<input type="checkbox"/>	64
19 寫信	<input type="checkbox"/>	<input type="checkbox"/>	<input type="checkbox"/>	<input type="checkbox"/>	<input type="checkbox"/>	<input type="checkbox"/>	65
20 去睇戲	<input type="checkbox"/>	<input type="checkbox"/>	<input type="checkbox"/>	<input type="checkbox"/>	<input type="checkbox"/>	<input type="checkbox"/>	66
21 參加社團或其他聚會 (例：同鄉會，街坊會)	<input type="checkbox"/>	<input type="checkbox"/>	<input type="checkbox"/>	<input type="checkbox"/>	<input type="checkbox"/>	<input type="checkbox"/>	75
22. 去行街買嘢(或行公司)	<input type="checkbox"/>	<input type="checkbox"/>	<input type="checkbox"/>	<input type="checkbox"/>	<input type="checkbox"/>	<input type="checkbox"/>	76
23. 參與社團或宗教團體嘅工作	<input type="checkbox"/>	<input type="checkbox"/>	<input type="checkbox"/>	<input type="checkbox"/>	<input type="checkbox"/>	<input type="checkbox"/>	77
24. 做運動	<input type="checkbox"/>	<input type="checkbox"/>	<input type="checkbox"/>	<input type="checkbox"/>	<input type="checkbox"/>	<input type="checkbox"/>	78
25. 打牌，捉棋或電視遊戲等	<input type="checkbox"/>	<input type="checkbox"/>	<input type="checkbox"/>	<input type="checkbox"/>	<input type="checkbox"/>	<input type="checkbox"/>	79
26. 遊車河	<input type="checkbox"/>	<input type="checkbox"/>	<input type="checkbox"/>	<input type="checkbox"/>	<input type="checkbox"/>	<input type="checkbox"/>	72
27 探親戚朋友	<input type="checkbox"/>	<input type="checkbox"/>	<input type="checkbox"/>	<input type="checkbox"/>	<input type="checkbox"/>	<input type="checkbox"/>	73
28. 招呼親戚朋友(返屋企坐，食飯，飲茶)	<input type="checkbox"/>	<input type="checkbox"/>	<input type="checkbox"/>	<input type="checkbox"/>	<input type="checkbox"/>	<input type="checkbox"/>	74

29. 睇書，睇報紙，雜誌	<input type="checkbox"/>	<input type="checkbox"/>	<input type="checkbox"/>		<input type="checkbox"/>	<input type="checkbox"/>	<input type="checkbox"/>	75
30. 冇嘢做坐响度穩嘢	<input type="checkbox"/>	<input type="checkbox"/>	<input type="checkbox"/>		<input type="checkbox"/>	<input type="checkbox"/>	<input type="checkbox"/>	76
31. 同屋企人傾偈	<input type="checkbox"/>	<input type="checkbox"/>	<input type="checkbox"/>		<input type="checkbox"/>	<input type="checkbox"/>	<input type="checkbox"/>	77
32. 去旅行（本地或出外）	<input type="checkbox"/>	<input type="checkbox"/>	<input type="checkbox"/>		<input type="checkbox"/>	<input type="checkbox"/>	<input type="checkbox"/>	78
33. 拍拖或同配偶去街	<input type="checkbox"/>	<input type="checkbox"/>	<input type="checkbox"/>		<input type="checkbox"/>	<input type="checkbox"/>	<input type="checkbox"/>	79
34. 行房或者同異性親熱或性交	<input type="checkbox"/>	<input type="checkbox"/>	<input type="checkbox"/>		<input type="checkbox"/>	<input type="checkbox"/>	<input type="checkbox"/>	80
35. 冇嘢做坐响度望吓嘢	<input type="checkbox"/>	<input type="checkbox"/>	<input type="checkbox"/>		<input type="checkbox"/>	<input type="checkbox"/>	<input type="checkbox"/>	81
36. 賭馬	<input type="checkbox"/>	<input type="checkbox"/>	<input type="checkbox"/>		<input type="checkbox"/>	<input type="checkbox"/>	<input type="checkbox"/>	82

完

謝謝你的合作，閣下所提供的資料將會幫助  
強直患者服務的推展

#### IV THE ANKYLOSING SPONDYLITIS PHAB CLUB IN HONG KONG

M.B. Lee & E. Ho

M.B. Lee – Chairman, The Hong Kong Society for Rehabilitation

E. Ho – Lecturer, Department of Orthopaedic Surgery, Queen Mary Hospital, University of Hong Kong, Hong Kong.

An attempt to centralise the ankylosing spondylitics started in 1982 at the Duchess of Kent Children's Hospital at Sandy Bay, Hong Kong. At first, we started with only a handful of patients. However there was a steady number of referrals from all over Hong Kong.

In September 1983, already there were 150 spondylitics seen regularly at that centre. In order to form a stronger bond between these patients, a club was formed. This was done through the help of the P.H.A.B. Association (Physically Handicapped and Abled Body). It was named the Ankylosing Spondylitis PHAB Club. This club held regular meetings – both recreational and educational in nature. Increasing number of ankylosing spondylitics were being recruited. It has more than 150 members now.

This club has a consultation committee of doctor, physical therapist, occupational therapist, medical social worker and clinical psychologist. They are all interested in this disease. These spondylitics could attend seminars held by some of these faculties, in an attempt to understand the various aspects of their disease.

The formation of this club certainly strengthens the morale of these patients. It is hope that such bondage between members could persist and strengthen more in the future.



## V THE FUTURE OF ANKYLOSING SPONDYLITICS IN HONG KONG

E. Ho  
Lecturer  
Department of Orthopaedic Surgery  
Queen Mary Hospital  
University of Hong Kong  
Hong Kong

Preliminary work and setup for centralisation, monitoring and research into the specific disease of ankylosing spondylitis had been started in Hong Kong. A surprisingly large and yet increasing population of the spondylitics had been integrated into this program. This report only mentioned some of the works available for review now. Obviously more medical and paramedical studies are being completed, in the near future.

The future directions in the management of this condition will be three-folded.

First, more basic research into the pathogenesis of this disease is necessary. It is most appropriate to start a multi centre study on this disease in the South East Asian area where this disease is fairly prevalent. Special attention must be paid to the immunological and epidemiological aspects.

Secondly, attention must be paid to the multi faceted nature of treatment of this disease. Co-operation between rheumatologist, immunologist, orthopaedic surgeons, paramedical staffs and the family physicians is essential. Our centralisation procedure partly fulfilled this. Prevention of difficult deformities are not impossible and certainly properly directed hip and spinal operations could correct deformities also. This could only be successful if both early and late cases were referred to well equipped centres with interested personelle.

Thirdly, there will be the problem of integration of these spondylitics back into society. This in fact will be the biggest problem among the three. I hope our little work shall illuminate the problem so that all involved, especially those working for rehabilitation, will join in and help.

We have began our way, hopefully the correct one. I hope someday we shall mature and attain the goals.

X15506537

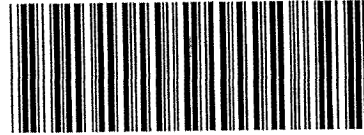

M 616.73 H67                      X15506537  
Ho, King-wah, Eric.  
Report of work on ankylosing spondylitics  
in Hong Kong, 1982-1985 / [by] Eric Ho.  
Hong Kong : Department of Orthopaedic  
Surgery, University of Hong Kong, [1986]