

Chaoization of DC Motors for Industrial Mixing

S. Ye and K. T. Chau, *Senior Member, IEEE*

Abstract—Conventional industrial mixing is ineffective, which consumes a lot of energy. In this paper, an effective mixing approach is proposed and implemented by using an electrical chaoization. Namely, a permanent-magnet dc motor, which acts as the agitator, is electrically chaoized by time-delay feedback control. It is identified that there are three adjustable control parameters: the torque parameter which induces chaotic motion, the speed parameter which adjusts the motion boundary, and the time-delay parameter which tunes the refreshing rate. Both computer simulation and experimental results are given to verify the proposed chaoization. Finally, realistic mixing of an acid-base solution is used to verify the effectiveness of the proposed chaotic mixing.

Index Terms—Chaos, mixing, motion control, motors.

I. INTRODUCTION

INDUSTRIAL mixers are one of the most important mixing devices in food, drug, chemical, and semiconductor industries. One of the major problems of conventional mixers is the formation of segregated regions when mixing fluids with low Reynolds numbers [1]. The occurrence and persistence of these segregated regions require extensive energy consumption for mixing. As a result, industrial mixers are one of the most ineffective equipment. The industrialists and academics in the USA have estimated that the cost of ineffective industrial mixing is on the order of U.S. \$ 1–10 billion per annum [2]. The effects of this ineffectiveness are not only energy wastage [3] but also can be disastrous (a nuclear-chemical waste explosion in Russia has been attributed to improper mixing of chemicals) [4]. Although mixing can be improved by increasing the rotational speed, such high-speed operation generally consumes additional energy and is sometimes impractical. Particularly, some shear-sensitive materials for biotechnological applications, such as proteins and other macromolecules, are readily damaged by high shear rates when adopting high rotational speed. Thus, the improvement of mixing is highly desirable and justifiable.

In order to improve the mixing process, time-varying rotation has been proposed [5], aiming to destroy the segregated regions formed in the mixing process. Among the various time-varying schemes, bidirectional rotations with different frequencies are adopted for industrial mixing. In addition, the bidirectional rotation can be further modulated by a sinusoidal wave. The use of time-varying rotation to improve mixing is due to the principle that the flow is continuously perturbed,

hence preventing the formation of coherent segregated regions. Conceptually, it is similar to kneading the bread dough where the dough is stretched and folded repeatedly to create good mixing.

In recent years, time-varying rotational mixing has been further extended to chaotic mixing because chaos inherently offers the properties of stretching and folding which match with the aforementioned requirement of good mixing [6]. Although there are many studies on chaotic mixing, only a few approaches are considered to be practical. In [7], by properly designing the radius of chamber wall, the radius of twin rotors, and the gap size and, then, separately controlling the rotational speeds, a twin-screw mixer was developed for chaotic mixing. In [8], by moving one of the vanes in the central impeller upward by half the vane height and one adjacent vane downward by the same distance, a perturbed three-impeller design was proposed to create chaotic motion for mixing. In [9], by continuously varying the angle of the impeller shaft with respect to the vertical axis, a chaotic mixer was also created. However, all these chaotic mixers generate the desired chaotic motion by using mechanical means, thus suffering from two fundamental problems—complexity and inflexibility. First, the complex configurations significantly increase the system cost, enlarge the hardware size, and reduce the operation reliability. Second, the inflexible designs definitely limit the applicability and generality since the mixing materials and the mixing tanks are prone to changing. In order to fundamentally solve these problems, our idea is to electrically produce the desired chaotic motion for mixing [10].

Since the 1990s, a number of research activities on chaos in electric motors have been carried out. Most of them are based on the identification of chaos [11], the avoidance of chaos [12], and the stabilization of chaos [13] in various types of electric motors. Rather than negatively avoiding the occurrence of chaos in motors, a positive idea is to utilize the chaotic motion for some niche applications. Chaotic behavior has recently been utilized in the areas of cryptography [14] and power converters [15]. Therefore, the purpose of this paper is to newly chaoize a motor, hence resulting in a controllable chaotic motion, for application to industrial mixing processes. Compared with the aforementioned mechanical means, the proposed chaotic-motion motor not only produces the desired chaotic mixing but also offers the advantages of mechanical simplicity, high flexibility, and high controllability. The key is to newly propose and implement the chaoization of the dc motor (the agitator) using the time-delay feedback control [16], [17].

There are many methods to evaluate the mixing processes, which can be divided into two categories: intrusive and non-intrusive. The intrusive methods include a probe or tracer that

Manuscript received January 24, 2006; revised July 26, 2006. This work was supported by a grant (Project HKU 7154/04E) from the Research Grants Council of Hong Kong Special Administrative Region, China.

The authors are with the Department of Electrical and Electronic Engineering, The University of Hong Kong, Hong Kong (e-mail: ktchau@eee.hku.hk).
Digital Object Identifier 10.1109/TIE.2007.895150

is put in the stirred tank to measure flow velocities, but the methods disturb the flow patterns that the investigators intend to measure. The nonintrusive methods, such as the laser Doppler anemometer [18] and the acid-base neutralization reaction [19], are more attractive since they will not disturb the flow patterns. Increasingly, the acid-base neutralization reaction takes the advantages of simple arrangement and low cost. This method will be employed to evaluate the proposed chaotic mixing.

In Section II, the theoretical derivation of the proposed chaotic motor will be provided. Then, in Section III, the computer simulation and experimental results will be presented to illustrate the corresponding chaotic motion. The implementation of the whole system will be discussed in Section IV. In Section V, the results of chaotic mixing and other mixing methods under the same power level will be compared to verify the anticipated effectiveness. Finally, conclusions will be drawn in Section VI.

II. CHAOTIC MOTOR

In this paper, a permanent-magnet (PM) dc motor is used as the agitator, which can be modeled as

$$\frac{d}{dt} \begin{pmatrix} \omega \\ i \end{pmatrix} = \begin{pmatrix} -\frac{B}{J} & \frac{K}{J} \\ -\frac{K}{L} & -\frac{R}{L} \end{pmatrix} \begin{pmatrix} \omega \\ i \end{pmatrix} + \begin{pmatrix} -\frac{T_1}{J} \\ \frac{U}{L} \end{pmatrix} \quad (1)$$

$$T = Ki \quad (2)$$

where B is the viscous damping coefficient, J is the load inertia, K is the torque constant, L is the armature inductance, R is the armature resistance, T is the motor torque, T_1 is the load torque, U is the dc supply voltage, ω is the motor speed, and i is the armature current. When the motor is current-fed, the order of the system equation can be reduced. In case T_1 is negligible, the system (1) can be represented by a single-input single-output (SISO) linear time-invariant (LTI) system

$$\frac{d\omega}{dt} + \frac{B}{J}\omega = \frac{T}{J} \quad (3)$$

where T and ω are the input and output of the system, respectively. Consequently, by employing anticontrol of chaos in continuous-time systems [20], the proposed time-delay feedback control is designed as

$$T = \mu\xi Bf\left(\frac{\omega(t-\tau)}{\xi}\right) \quad (4)$$

where μ is the torque parameter, ξ is the speed parameter, and τ is the time-delay parameter. It should be noted that all three parameters are adjustable to achieve the desired chaotic motion. In addition, $f(\cdot)$ should be a bounded function to satisfy the condition that the required torque will not exceed the motor-torque capability. Substituting (4) into (3), the time-delay system equation can be formulated as

$$\frac{d\omega}{dt} + \frac{B}{J}\omega = \frac{\mu\xi Bf\left(\frac{\omega(t-\tau)}{\xi}\right)}{J} \quad (5)$$

Defining the normalized speed $\Omega = \omega/\xi$, (5) is rewritten as

$$\frac{d\Omega}{dt} + \frac{B}{J}\Omega = \frac{\mu Bf(\Omega(t-\tau))}{J} \quad (6)$$

For a SISO LTI system, it can be expressed as

$$y^{(n)}(t) + \alpha_{n-1}y^{(n-1)}(t) + \dots + \alpha_1y^{(1)}(t) + \alpha_0y(t) = \beta_0u(t) \quad (7)$$

where $u(t)$ is the input, $y(t)$ is the output, and α_i ($i = 0, \dots, n-1$) and β_0 are the constants with $\alpha_0\beta_0 \neq 0$. When the system is incorporated with the time-delay feedback control, $u(t)$ and $y(t)$ are related by

$$u(t) = w(y(t-\tau)) \quad (8)$$

where $w(\cdot)$ is a bounded continuous function. According to [20], a time-delay differential equation can be asymptotically approximated by a difference equation as given by

$$y(m, \hat{t}) \approx \frac{\beta_0}{\alpha_0}w(y(m-1, \hat{t})), \text{ and } y^{(k)}(m, \hat{t}) \approx 0 \quad (9)$$

where $y(m, \hat{t}) = y(m\tau + \hat{t})$, for $m = 0, 1, \dots$, and $k = 1, 2, \dots, n-1$, τ is sufficiently large, and $\hat{t} : t_0 < \hat{t} < \tau$ is large.

For the proposed chaotic motor, $\alpha_0 = B/J$, $\beta_0 = \mu B/J$, and $w(\cdot)$ are represented by $f(\cdot)$. Hence, by using (9), (6) can be asymptotically approximated by

$$\Omega(m, \hat{t}) = \mu f(\Omega(m-1, \hat{t})) \quad (10)$$

Since a sine function is a continuous bounded function, it is naturally chosen as $f(\cdot)$ in (10). Hence, the system equation can be expressed as

$$\Omega_m = \mu \sin \Omega_{m-1} \quad (11)$$

By writing $\mu = \pi r$ and $\Omega_m = \pi X_{n+1}$, (11) can be expressed as

$$X_{n+1} = r \sin \pi X_n \quad (12)$$

which has been proved by Strogatz [21] that it exhibits chaotic behavior with certain values of r . Therefore, the proposed time-delay feedback control scheme given by (4) is rewritten as

$$T = \mu\xi B \sin\left(\frac{\omega(t-\tau)}{\xi}\right) \quad (13)$$

which can offer chaotic motion by selecting appropriate values of μ , ξ , and τ .

In order to implement the proposed chaotic motor based on the aforementioned derivation, both the armature current

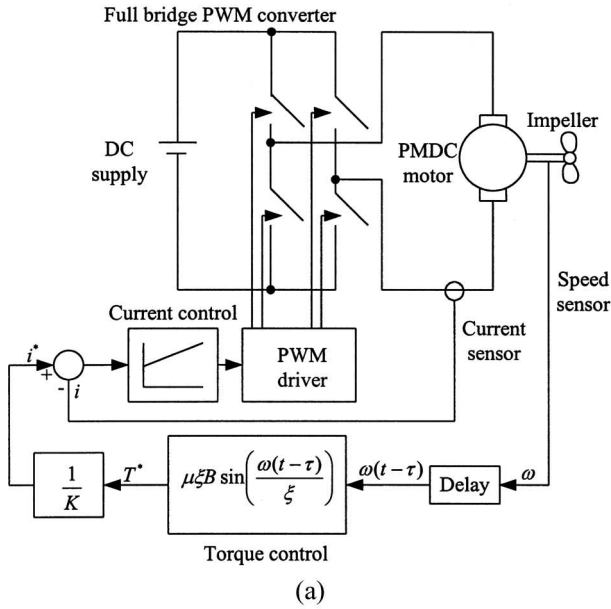

Fig. 1. Proposed chaotic motor for industrial mixing. (a) Control system. (b) Experimental setup.

and the rotor speed of the PM dc motor are used as feedback signals, while the torque command T^* calculated by (13) is used to generate the current command i^* for PWM control of the PM dc motor. Fig. 1 shows the corresponding control system and experimental setup. First, the measured speed feedback is delayed by a preset value of τ . Then, the

TABLE I
MOTOR PARAMETERS

B	$1.0 \times 10^{-4} \text{ Nm/(rad/s)}$
J	$1.0388 \times 10^{-5} \text{ Nm/(rad/s}^2\text{)}$
K	0.05 Nm/A
L	0.4 mH
R	$1.1 \text{ } \Omega$
U	24 V

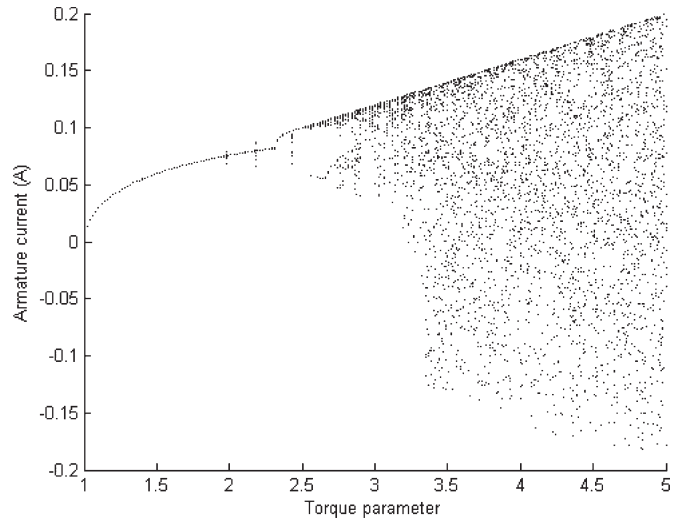
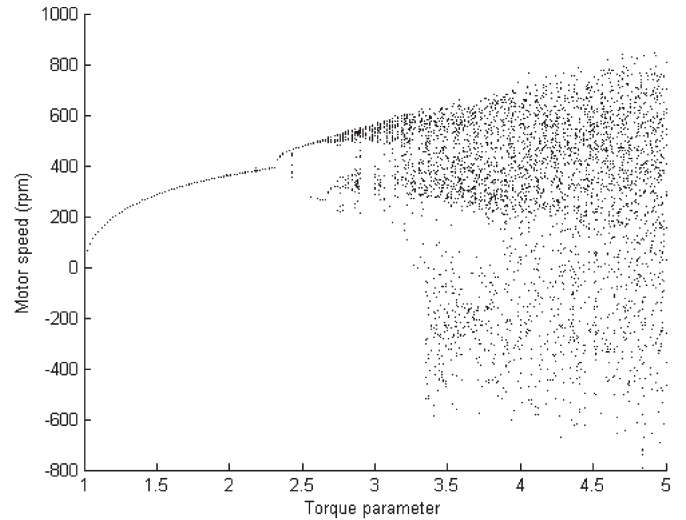

Fig. 2. Bifurcation diagrams with respect to the torque parameter. (a) Motor speed. (b) Armature current.

delayed speed is fed into the torque control block in which the proper values of μ and ξ are preset. Hence, it generates T^* and, then, i^* . Subsequently, the difference between i^* and the measured current feedback is fed into the current control block in which the simple PI control is adopted. Hence, it generates the desired duty ratio for the full-bridge PWM converter which provides bidirectional current control of the PM dc motor.

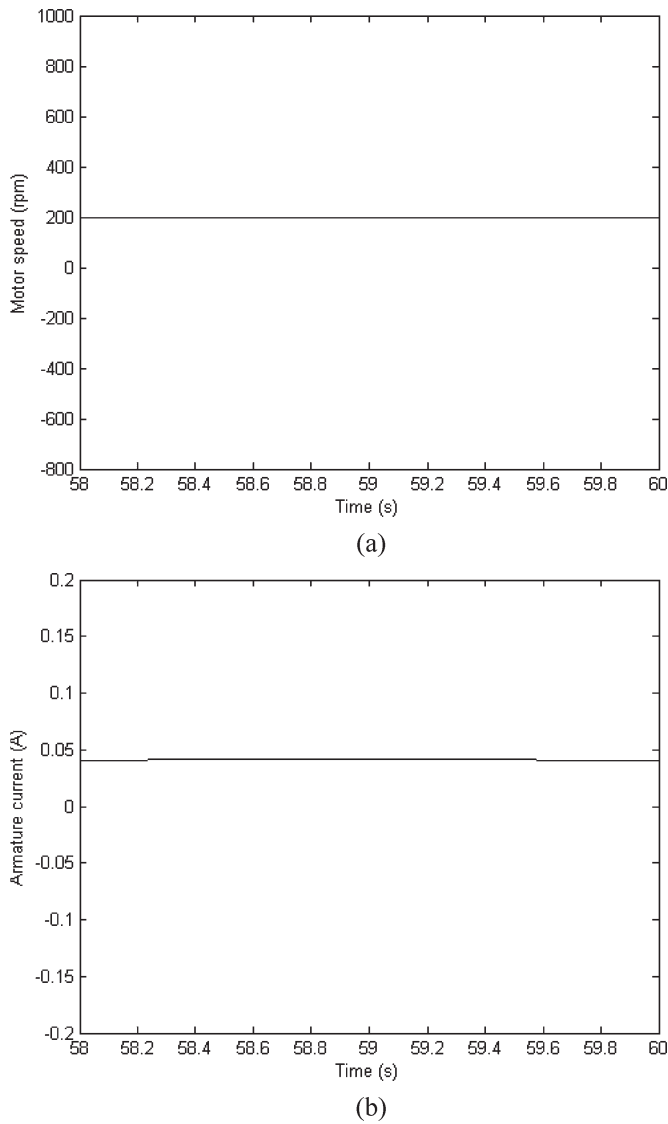

Fig. 3. Period-1 operation under the torque-parameter control. (a) Motor speed. (b) Armature current.

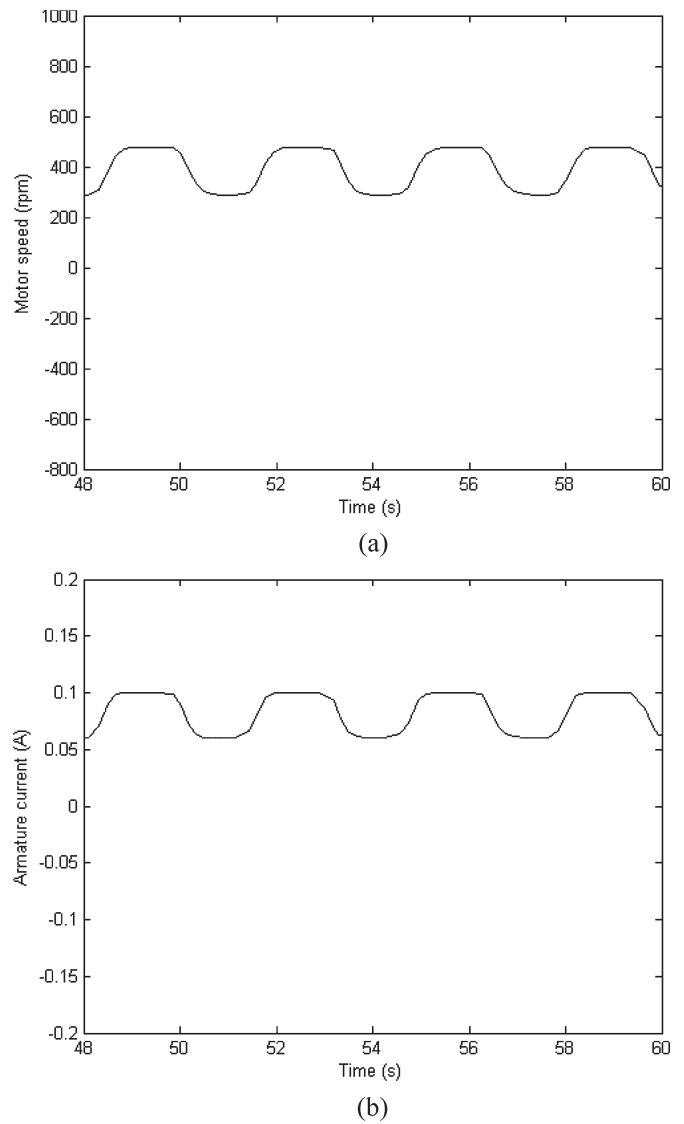

Fig. 4. Period-2 operation under the torque-parameter control. (a) Motor speed. (b) Armature current.

III. SIMULATION AND EXPERIMENTAL RESULTS

In order to conduct computer simulation, realistic system parameters are adopted. Table I lists some key data of the PM dc motor. Making use of (1), (2), and (13), bifurcation diagrams, with respect to various adjustable parameters, are readily deduced. These bifurcation diagrams can illustrate how the system behavior is affected by varying the parameters at a glance. For the sake of illustration, the case of no load torque $T_1 = 0$ is adopted for simulation.

When selecting $\xi = 20$ and $\tau = 1.5$ s, both the speed and current bifurcation diagrams with respect to μ are shown in Fig. 2. It is shown that the motor initially operates at a fixed point (which is equivalent to normal or so-called the period-1 operation) with a small value of μ . Fig. 3 shows the corresponding motor speed and armature current waveforms when $\mu = 1.2$. With the increase of μ , the motor bifurcates to the period-2 operation which is equivalent to an abnormal subharmonic operation. Fig. 4 shows the corresponding speed and current when $\mu = 2.5$. Finally, the motor exhibits chaotic

motion when μ is further increased. Fig. 5 shows the corresponding speed and current when $\mu = 5$. When the motor is run in the chaotic mode, both the amplitude and direction of the motor speed and armature current change with time and present ergodicity in the range shown in Fig. 2. It is this character of ergodicity that differs the chaotic mixing from the normal constant-speed mixing. Therefore, the torque parameter μ is the key to induce the chaotic motion from the normal operation.

On the other hand, when selecting $\mu = 5$ and $\tau = 1.5$ s, both the speed and current bifurcation diagrams with respect to ξ are shown in Fig. 6. It is shown that ξ can be used to approximately linearly adjust the speed range of the chaotic motion, and that is why it is named the speed parameter. Therefore, the speed parameter ξ serves to adjust the boundary of chaotic motion for the proposed chaoization.

Furthermore, when selecting $\mu = 5$ and $\xi = 20$, the corresponding bifurcation diagrams with respect to τ are shown in Fig. 7. It can be observed that the change of τ has little effect

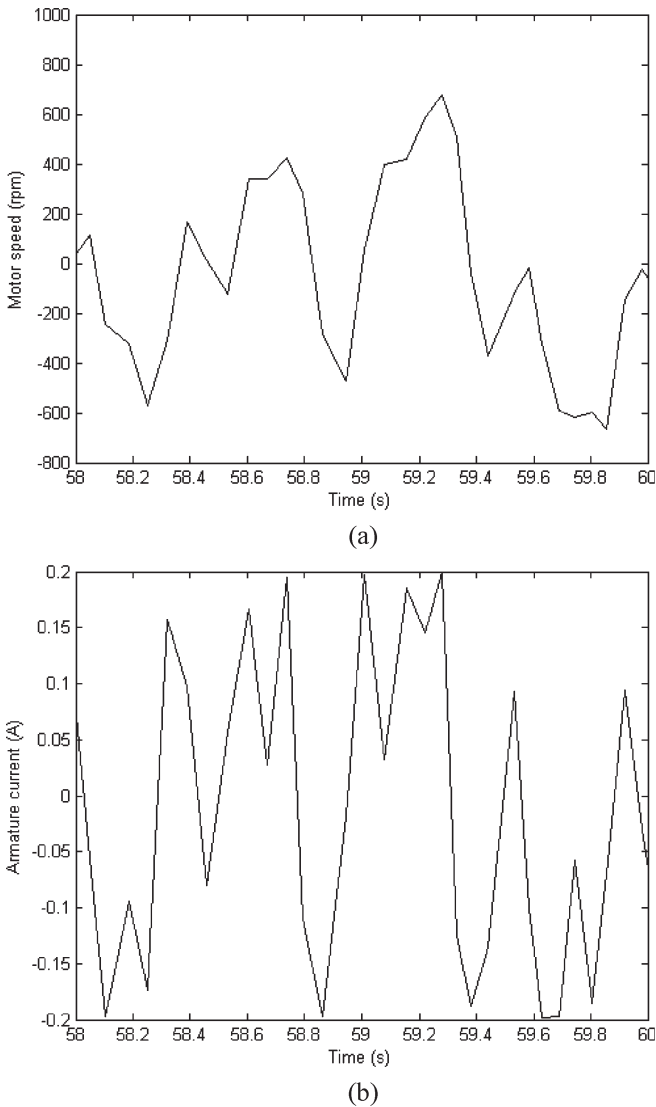

Fig. 5. Chaotic operation under the torque-parameter control. (a) Motor speed. (b) Armature current.

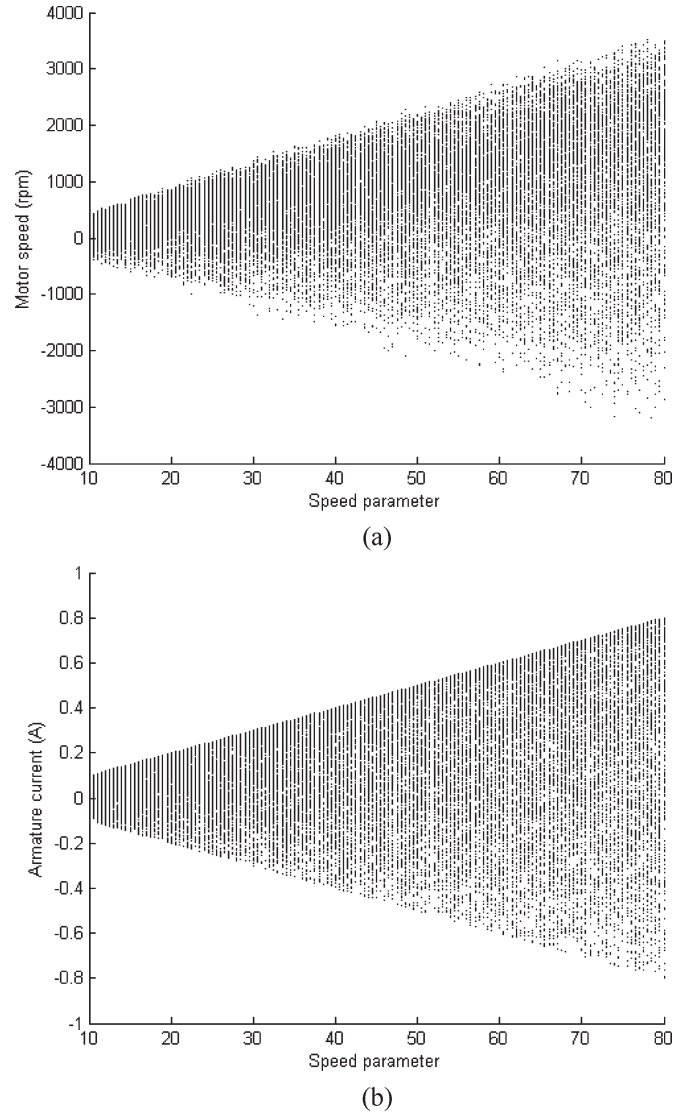

Fig. 6. Bifurcation diagrams with respect to speed parameter. (a) Motor speed. (b) Armature current.

on the speed range of the chaotic motion. Nevertheless, this parameter has a significant impact on the system realization. If the parameter is too large, the refreshing rate of the control system is too slow, while if the parameter is too small, it requires too much computational resource. Therefore, the time-delay parameter τ functions to tune the refreshing rate of the proposed chaoticization.

In order to verify the aforementioned simulation results, experimentation is performed based on the same parameter settings. Fig. 8 provides a comparison of the corresponding simulated and measured waveforms. First, Fig. 8(a) and (b) shows the simulated waveforms of motor speed and armature current under normal operation ($\mu = 1.2$, $\xi = 200$, and $\tau = 1.5$ s), respectively, while Fig. 8(c) shows the measured normal waveforms of motor speed and armature current under the same conditions. It is shown that the agreement is very good. Second, Fig. 8(d) and (e) shows the simulated waveforms of motor speed and armature current under chaotic operation ($\mu = 35$, $\xi = 20$, and $\tau = 1.5$ s), respectively, while

Fig. 8(f) shows the measured chaotic waveforms of motor speed and armature current under the same conditions. It is shown that both the simulated and measured waveforms exhibit chaotic behavior but with different patterns. It is expected because the chaotic behavior is not periodic such that the period of measurement cannot be the same with that of simulation. Nevertheless, it can be found that the measured boundaries of the chaotic waveforms match with the simulated ones. It is actually the nature of chaos—random-like but bounded.

It should be noted that the aforementioned results are under no-load condition only. The reason is due to the fact that the mathematical modeling of fluid dynamics during mixing is too complicated to be handled in this paper. The corresponding fluid dynamics involve a set of partial differential equations that is so-called the Navier–Stokes equations which can only be solved by using the sophisticated methods such as the 3-D finite element method [9]. Therefore, in this paper, both simulation and experimental results are used to illustrate the

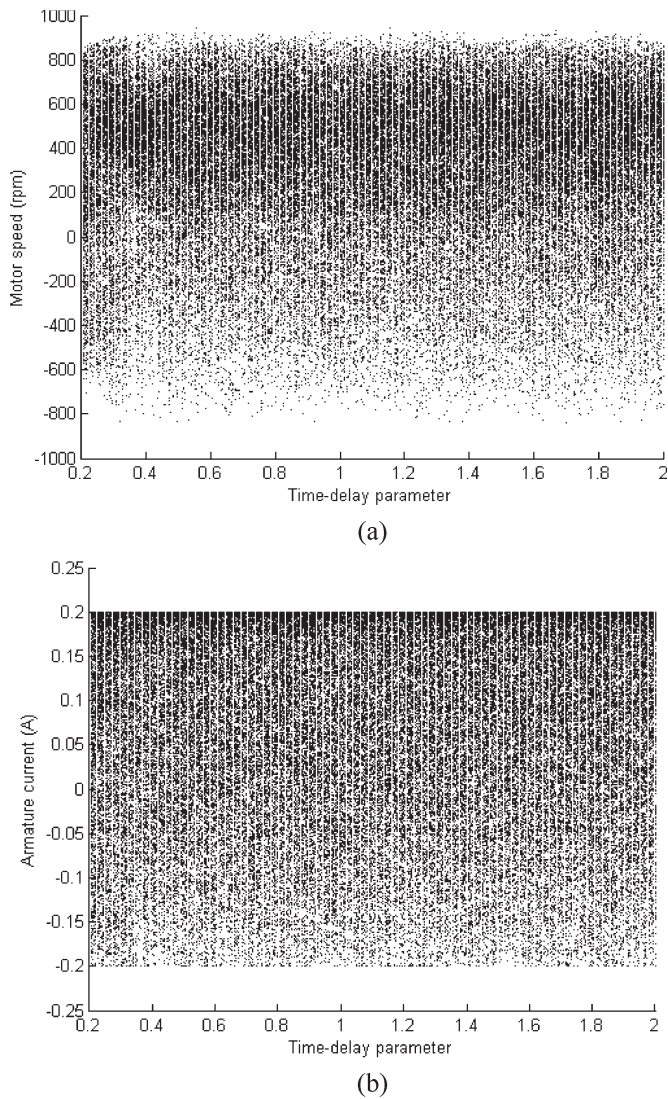

Fig. 7. Bifurcation diagrams with respect to time-delay parameter. (a) Motor speed. (b) Armature current.

chaoization of the motor, whereas only the experimental results will be used to illustrate the chaotic mixing process in which the mixing load is taken into account [5].

IV. MIXING SYSTEM

The mixing system consists of a tank and an impeller spun by a digitally controlled motor drive. The motor is mounted vertically on a stand with its shaft positioned at the center of the tank. The shaft is mounted through a holding plate, which ensures consistent positioning between the experiments and minimizes oscillations of the shaft tip. As shown in Fig. 1(b), the motor is a Sanyo R406 PM dc servo motor, the stand is a Bosch BS 35 drill holder, and the tank is a 1-l glass beaker.

It should be noted that the mixture with a low or moderate Reynolds number is particularly difficult to achieve an effective mixing since the corresponding flow is laminar, whereas the mixture with high Reynolds number can easily achieve an effective or so-called turbulent mixing [22]. Thus, in this paper,

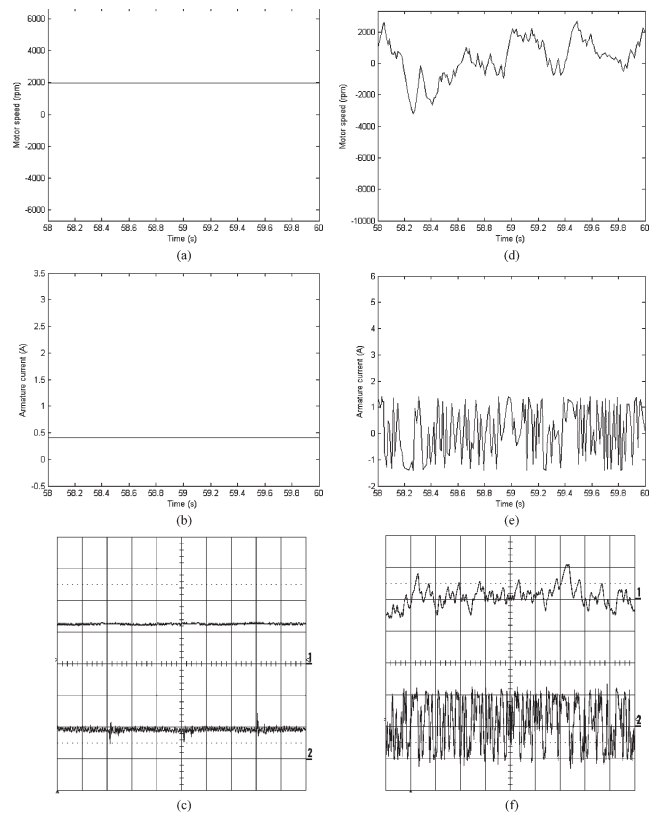

Fig. 8. Comparison of motor speed and armature current waveforms. (a) Simulated normal motor speed. (b) Simulated normal armature current. (c) Measured normal motor speed and armature current (1666.7 r/min/div, 0.5 A/div, and 0.2 s/div). (d) Simulated chaotic motor speed. (e) Simulated chaotic armature current. (f) Measured chaotic motor speed and armature current (1666.7 r/min/div, 1 A/div, and 0.2 s/div).

TABLE II
COMPARISON OF DIFFERENT MIXING METHODS

Mixing Method	Time (s)
Constant-speed	360
Rectangularly bidirectional	33
Sinusoidally bidirectional	33
Chaotic	30

a viscous solvent (light corn syrup) is purposely adopted so that the mixing effectiveness can be evaluated.

First, the tank is filled with 200-ml light corn syrup, 5-ml pH indicator solution (universal indicator), and 5-ml solution of 1 N HCl. The solution is mixed until a uniform red color is observed since it is acidic. Next, another well-mixed solution (dark green color) of 100-ml light corn syrup, 2.5-ml pH indicator solution, and 2.5-ml 1 N NaOH is added into the tank. Although the whole solution is acidic as there is twice as much acid as base, there are dark green regions since diffusion is limited by the viscous solvent (light corn syrup).

The beginning of the mixing process of the acid-base solution is set as the time zero. The motor drive is controlled by a dSPACE digital controller to realize various mixing methods, including constant-speed, periodic, and chaotic motions. The whole experimentation is recorded by using a camera focused at the impeller.

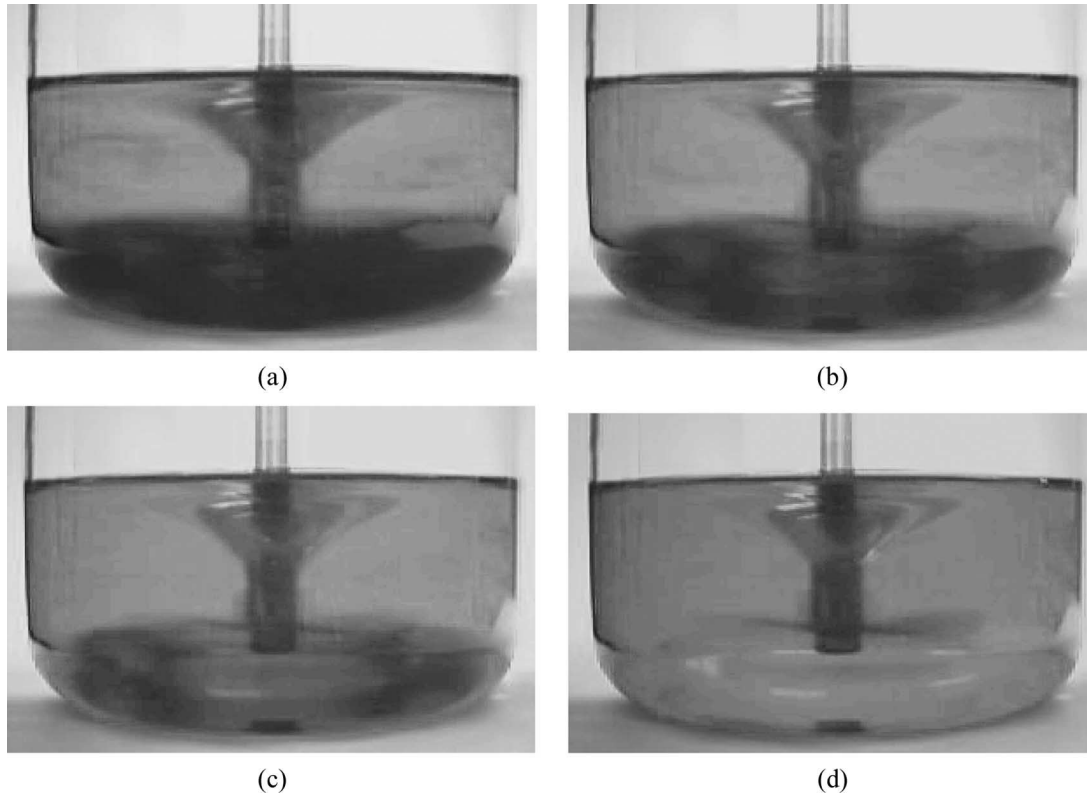

Fig. 9. Coloration during constant-speed mixing. (a) After 5 s. (b) After 10 s. (c) After 20 s. (d) After 360 s.

V. MIXING RESULTS

To assess whether chaotic mixing is more effective than other mixing methods, it is equivalent to evaluate whether chaotic mixing can offer a more homogenous mixture under the same amount of energy consumption. The experiment is designed to compare the mixing time needed to achieve homogeneity based on the same input power. First, the chaotic mixing experiment is conducted. The input voltage and current are online recorded until homogeneity is achieved. Hence, the average input power is calculated. Then, the other mixing methods, namely, the conventional constant-speed mixing, the rectangularly bidirectional mixing, and the sinusoidally bidirectional mixing, are also conducted under the same input power for comparison.

As tabulated in Table II, the proposed chaotic mixing ($\mu = 30$, $\xi = 20$, and $\tau = 1.5$ s) takes 4.2 W to fully mix up the aforementioned acid-base solution within 30 s, whereas the constant-speed mixing at 600 r/min requires 360 s, the rectangularly bidirectional mixing with a magnitude of 600 r/min and a frequency of 0.5 Hz requires 33 s, and the sinusoidally bidirectional mixing with an amplitude of 850 r/min and a frequency of 0.5 Hz also requires 33 s, all under the same power of 4.2 W. Thus, it quantitatively verifies that the proposed chaotic mixing takes the definite advantages of shorter mixing time and, hence, lower energy consumption than the others, particularly the conventional constant-speed mixing.

The improvement is expected since the constant-speed mixing process involves the formation of segregated region which is the major obstacle for effective mixing, whereas the chaotic

mixing process essentially prevents the formation of segregated regions. Fig. 9 shows the coloration of the constant-speed mixing process, which illustrates that the segregated region (alike a donut) persists for a long time. On the other hand, Fig. 10 shows the coloration of the chaotic mixing process, which confirms that no segregated region occurs. For the two bidirectional mixing processes, there are segregated regions formed during the positive or negative sessions, but the change of direction leads to the destruction of larger donuts and, then, the formation of smaller ones. Therefore, these two bidirectional mixing processes still take a longer time than the chaotic mixing, although showing significant improvement over the conventional constant-speed mixing.

As mentioned, the segregated region is the key obstacle for the conventional constant-speed mixing process to achieve effective mixing. Reference [8] has identified that the size of this region depends on the Reynolds number of the mixture—in general, the lower the Reynolds number, the larger is the segregated regions. Thus, the proposed chaotic mixing is particularly attractive for mixing those highly viscous fluids which have a low or moderate Reynolds number.

VI. CONCLUSION

In this paper, chaotic mixing has been electrically implemented by applying the time-delay feedback control to a PM dc motor, which acts as the agitator. Based on the derived system dynamic equations, three control parameters have been identified for the proposed chaotic mixing, namely, the torque parameter serves to induce the chaotic motion, the speed

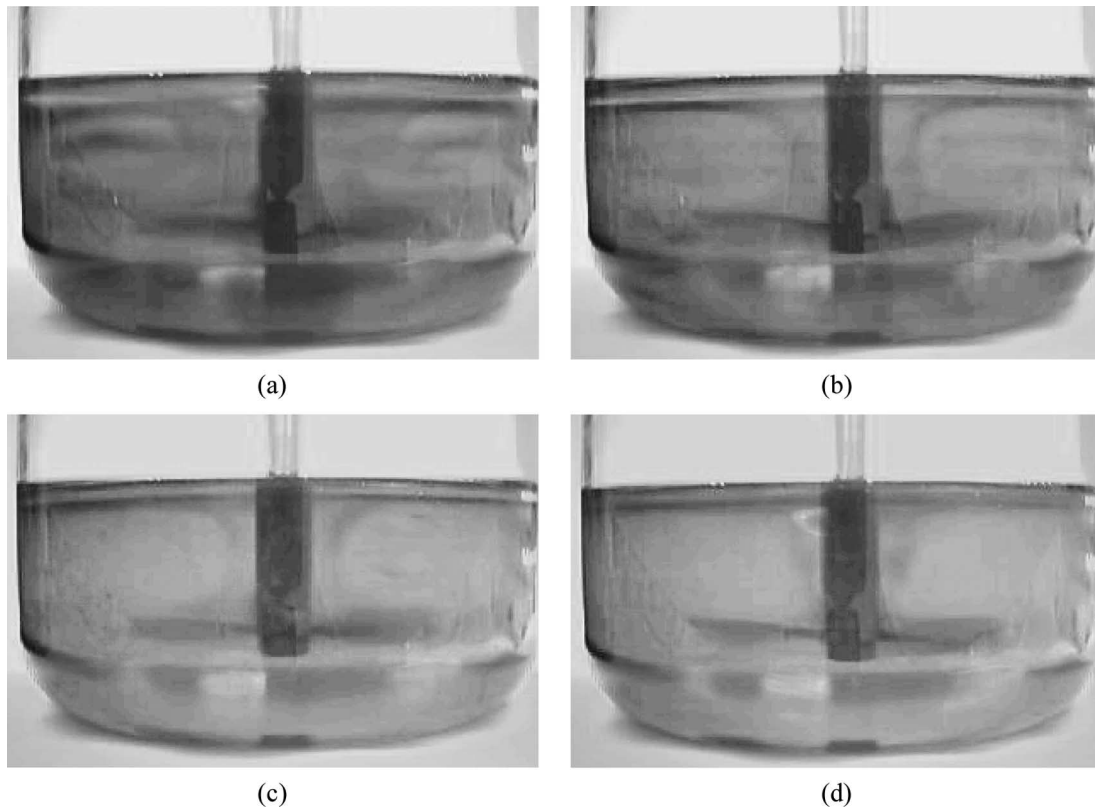

Fig. 10. Coloration during chaotic mixing. (a) After 5 s. (b) After 10 s. (c) After 20 s. (d) After 30 s.

parameter to adjust the chaotic boundary, and the time-delay parameter to tune the refreshing rate of control. Both simulation and experimental results have verified the proposed method of chaoization. Finally, realistic mixing processes have been performed which confirms that the proposed chaotic mixing can prevent the formation of segregated region and, hence, shorten the mixing time than the other mixing methods (the constant-speed, the rectangularly bidirectional, and the sinusoidally bidirectional ones).

REFERENCES

- [1] L. Dong, S. T. Johansen, and T. A. Engh, "Flow induced by an impeller in an unbaffled tank—I. Experimental," *Chem. Eng. Sci.*, vol. 49, no. 4, pp. 549–560, 1994.
- [2] N. Hamby, M. F. Edwards, and A. W. Nienow, *Mixing in the Process Industries*. Oxford, U.K.: Butterworth-Heinemann, 1992.
- [3] F. Raynal and J. N. Gence, "Energy saving in chaotic laminar mixing," *J. Heat Mass Transfer*, vol. 40, no. 14, pp. 3267–3273, 1997.
- [4] "Nuclear safety: Concerns with nuclear facilities and other sources of radiation in the former Soviet Union," United States General Accounting Office, Letter Rep. GAO/RCED-96-4. Gaithersburg, Maryland: General Accounting Office, Nov. 7, 1995.
- [5] D. J. Lamberto, F. J. Muzzio, P. D. Swanson, and A. L. Tonkovich, "Using time-dependent rpm to enhance mixing in stirred vessels," *Chem. Eng. Sci.*, vol. 51, no. 5, pp. 733–741, 1996.
- [6] J. M. Ottino, *The Kinematics of Mixing: Stretching, Chaos, and Transport*. Cambridge, U.K.: Cambridge Univ. Press, 1989.
- [7] S. C. Jana and M. Sau, "Effects of viscosity ratio and composition on development of morphology in chaotic mixing of polymers," *Polymer*, vol. 45, no. 5, pp. 1665–1678, Mar. 2004.
- [8] M. M. Alvarez-Hernández, T. Shinbrot, J. Zalc, and F. J. Muzzio, "Practical chaotic mixing," *Chem. Eng. Sci.*, vol. 57, no. 17, pp. 3749–3753, 2002.
- [9] G. O. Fountain, D. V. Khakhar, I. Mezic, and J. M. Ottino, "Chaotic mixing in a bounded three-dimensional flow," *J. Fluid Mech.*, vol. 417, no. 1, pp. 265–301, 2000.
- [10] K. T. Chau, S. Ye, Y. Gao, and J. H. Chen, "Application of chaotic-motion motors to industrial mixing processes," in *Proc. IEEE IAS Annu. Meeting*, 2004, pp. 1874–1880.
- [11] J. H. Chen, K. T. Chau, and C. C. Chan, "Analysis of chaos in current-mode controlled dc drive systems," *IEEE Trans. Ind. Electron.*, vol. 47, no. 1, pp. 67–76, Feb. 2000.
- [12] Y. Gao and K. T. Chau, "Design of permanent magnets to avoid chaos in PM synchronous machines," *IEEE Trans. Magn.*, vol. 39, no. 5, pp. 2995–2997, Sep. 2003.
- [13] J. H. Chen, K. T. Chau, S. M. Siu, and C. C. Chan, "Experimental stabilization of chaos in a voltage-mode dc drive system," *IEEE Trans. Circuits Syst. I, Fundam. Theory Appl.*, vol. 47, no. 7, pp. 1093–1095, Jul. 2000.
- [14] R. C. Luo, L.-Y. Chung, and C.-H. Lien, "A novel symmetric cryptography based on the hybrid Haar wavelets encoder and chaotic masking scheme," *IEEE Trans. Ind. Electron.*, vol. 49, no. 4, pp. 933–944, Aug. 2002.
- [15] K. K. Tse, R. W.-M. Ng, H. S.-H. Chung, and S. Y. R. Hui, "An evaluation of the spectral characteristics of switching converters with chaotic carrier-frequency modulation," *IEEE Trans. Ind. Electron.*, vol. 50, no. 1, pp. 171–182, Feb. 2003.
- [16] X. F. Wang, G. Q. Zhong, K. S. Tang, K. F. Man, and Z. F. Liu, "Generating chaos in Chua's circuit via time-delay feedback," *IEEE Trans. Circuits Syst. I, Fundam. Theory Appl.*, vol. 48, no. 9, pp. 1151–1156, Sep. 2001.
- [17] Z. Wang and K. T. Chau, "Anti-control of chaos of a permanent magnet dc motor system for vibratory compactors," *Chaos, Solitons Fractals*, 2006, DOI: 10.1016/j.chaos.2006.06.105.
- [18] P. Mavros, "Flow visualization in stirred vessels, a review of experimental techniques," *Trans. Inst. Chem. Eng.*, vol. 79, pt. A, no. 2, pp. 113–127, 2001.
- [19] G. Ascanio, M. Brito-Bazán, E. Brito-De La Fuente, P. J. Carreau, and P. A. Tanguy, "Unconventional configuration studies to improve mixing times in stirred tanks," *Can. J. Chem. Eng.*, vol. 80, no. 4, pp. 558–565, 2002.
- [20] X. F. Wang, G. Chen, and X. Yu, "Anticontrol of chaos in continuous-time systems via time-delay feedback," *Chaos*, vol. 10, no. 4, pp. 771–779, Dec. 2000.
- [21] S. H. Strogatz, *Nonlinear Dynamics and Chaos*. Reading, MA: Addison-Wesley, 1994.
- [22] H. Chaté, E. Villermaux, and J.-M. Chomaz, *Mixing*. New York: Kluwer, 1999.



S. Ye was born in 1977. She received the B.Sc.(Eng.) and M.Sc. degrees in electrical and electronic engineering from Nanjing University of Aeronautics and Astronautics, Nanjing, China, in 2000 and 2003, respectively. She is currently working toward the Ph.D. degree in electrical and electronic engineering at The University of Hong Kong, Hong Kong.

Her research interests are design, modeling, and control of electric drives.



K. T. Chau (M'89–SM'04) received the B.Sc.(Eng.) (first-class honors), M.Phil., and Ph.D. degrees in electrical and electronic engineering from The University of Hong Kong, Hong Kong, in 1988, 1991, and 1993, respectively.

He is currently Professor in the Department of Electrical and Electronic Engineering and the Director of the International Research Center for Electric Vehicles, The University of Hong Kong. His teaching and research interests focus on three main areas: electric vehicles, electric drives, and power electronics. In these areas, he has published over 200 refereed technical papers. He is also the coauthor of a monograph, *Modern Electric Vehicle Technology* (Oxford Univ. Press, 2001).

Dr. Chau was the recipient of the Outstanding Young Researcher Award in 2003, the University Teaching Fellowship Award in 2004, and the Award for Innovative Excellence in Teaching, Learning and Technology in 2005.